

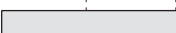



Capable of Setting the Sensing Range Using an Ultrasonic Beam

- Ensures the stable detection of a variety of objects regardless of the color, transparency, or material (metallic or non-metallic) of the objects.
- Limits the ultrasonic beam width to 8°, thus detecting minute objects as small as 2 x 2 cm.
- Detects objects smoothly while largely suppressing interference from background objects.
- Sealed to resist dust and dirt and emits ultrasonic waves at a frequency of approximately 200 kHz, thus providing high immunity from impact and environmental noise.



Ordering Information

Output configuration	Sensing method		Sensing distance	Model
DC switching NPN (normally open or closed selectable)	Through-beam		 50 cm	E4B-TS50E4
			 100 cm	E4B-T1E4
	Reflective	Convergent reflective (Distance adjustable)	 5 to 20 cm	E4B-LS20E4
			 20 to 70 cm	E4B-LS70E4
		Convergent reflective (Zone setting)	 20 to 70 cm Sensing zone	E4B-RS70E4

■ Sensing Method

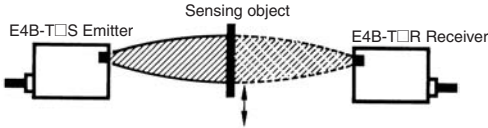
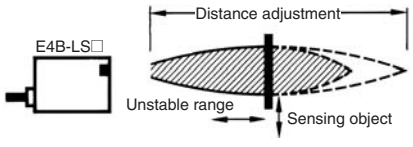
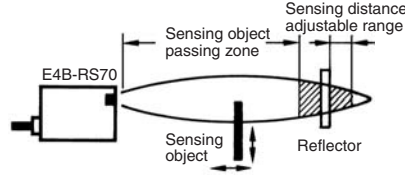
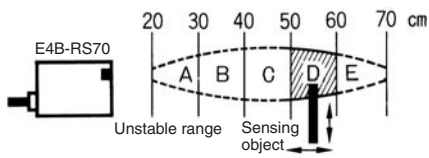
Through-beam		<p>Detects the attenuation or interrupted condition of the ultrasonic beam caused by the object passing between the Emitter and Receiver.</p> 
Reflective	Convergent reflective distance	<p>Detects only the beam reflected from the object existing within the sensing distance range set with the distance adjuster.</p> 
	Convergent reflective zone	<p>Detects the object with the interruption of the normal beam reflected from the reflector.</p> 
	Convergent reflective	<p>Detects only the beam reflected from the object existing in the sensing range set with the distance selector.</p> 

Note: An object may be detected due to multiple reflection if the object is in the unstable range where the distance adjuster is ineffective, in which case however, the detection of the object will not be stable. Therefore, do not attempt to use the E4B to detect an object in the unstable range.

Application Examples

Detection of a variety of transparent bottles in bottle manufacturing, drink processing, and food processing lines

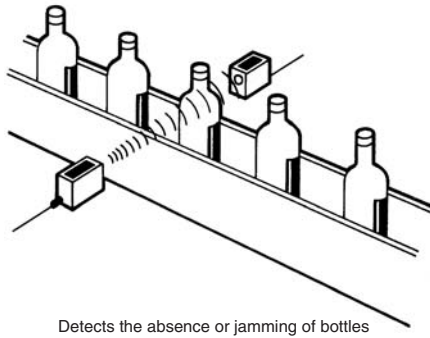

Detection of fluorescent lamps

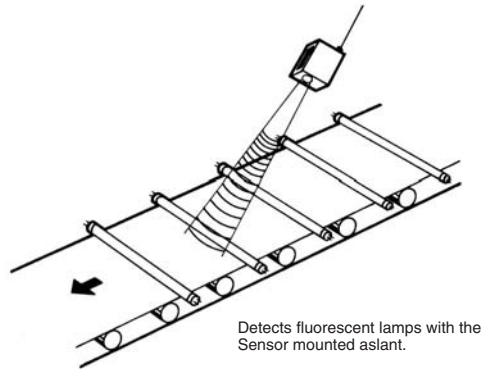

Specifications

■ Ratings/Characteristics

Item	Model	E4B-TS50E4	E4B-T1E4	E4B-LS20E4	E4B-LS70E4	E4B-RS70E4
Sensing method		Through-beam		Convergent reflective distance		Convergent reflective zone
	Sensing distance	50 cm	1 m	5 to 20 cm	20 to 60 cm (20 to 70 cm) (see note 1)	20 to 60 cm (20 to 70 cm) (see note 1) (in 10-cm divisions)
Supply voltage		12 to 24 VDC \pm 10% (10.8 to 26.4 VDC) with a max. ripple \pm 10% (p-p)				
Current consumption	12 VDC	Emitter: 155 mA max. Receiver: 30 mA max.	Emitter: 70 mA max. Receiver: 30 mA max.	100 mA max.		
	24 VDC	Emitter: 80 mA max. Receiver: 30 mA max.	Emitter: 50 mA max. Receiver: 30 mA max.	50 mA max.		
Standard sensing object		10 x 10 cm flat plate		4 x 4 cm flat plate		
Differential travel		---		20% max. of sensing distance		3 cm max.
Directional angle (see note 2)		\pm 8° max.				
Ultrasonic oscillation frequency		Approx. 200 kHz				
Response frequency (see note 4)		50 Hz	10 Hz	50 Hz	20 Hz	
Operating mode		Incident or interrupted (selectable)				
Control output		NPN, 100 mA at 30 VDC (with a residual voltage of 1.5 V max.) and an output resistance of 4.7 k Ω				
Indicators		SENSING indicator (red LED) and STABILITY indicator (green LED)				
Ultrasonic speed compensation		No				Yes
Ambient temperature		Operating: -10°C to 55°C				
Ambient humidity		Operating: 35% to 95%				
Temperature influence		\pm 10% max. of sensing distance at 20°C in the temperature range of -10°C and 55°C				
Voltage influence		\pm 5% max. of sensing distance at a voltage between 90% and 110% of the rated power supply voltage				
Residual voltage		1.5 V max. under a load current of 100 mA and a cord length of 2 m				
Insulation resistance		20 M Ω min. (at 500 VDC) between current carry parts and case				
Dielectric strength		1,000 V (50/60 Hz) for 1 min between current carry parts and case				
Vibration resistance		Destruction: 10 to 55 Hz, 1.5-mm double amplitude for 2 hours each in X, Y, and Z directions				
Shock resistance		Destruction: 500 m/s ² (approx. 50G) 3 times each in X, Y, and Z directions.				
Degree of protection (see note 3)		IEC IP66 (JEM IP66 water resistive)				
Weight (with 2-m-long cord and Mounting Bracket)		Approx. 600 g (with Emitter and Receiver)		Approx. 300 g		

- Note:**
1. These are the available sensing distances at an ambient temperature range between 0°C and 45°C .
 2. This is the half-value angle obtainable at a signal of -6 dB.
 3. The enclosure rating indicates the degree of protection of the case, which will depend on the operating condition.
 4. The response frequencies are values obtained with the E4B used for detecting a rotating propeller-shaped disc as shown on the right.

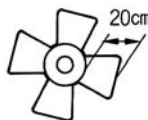

Space:Blade = 1:1

Engineering Data

Operating Distance vs. Sensing Object Size (Typical)

E4B-TS50E4, E4B-T1E4

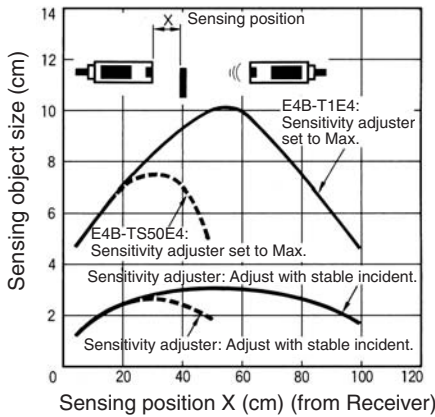

Note: The curve with the sensitivity adjuster set to maximum indicates the size of the sensing object.

E4B-LS20E4

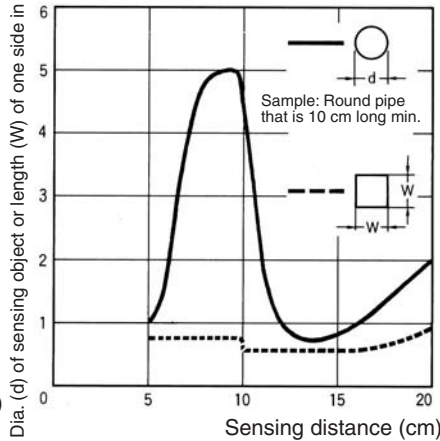

Note: The sensing method will change when the sensing distance exceeds 10 cm. As a result, the detectable diameters will change greatly.

E4B-LS70E4, E4B-RS70E4

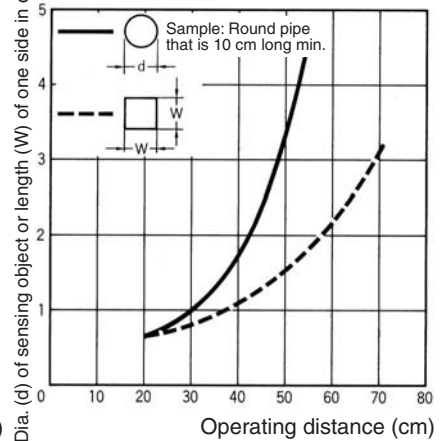

Operating Range Diagram (Typical)

E4B-LS20E4

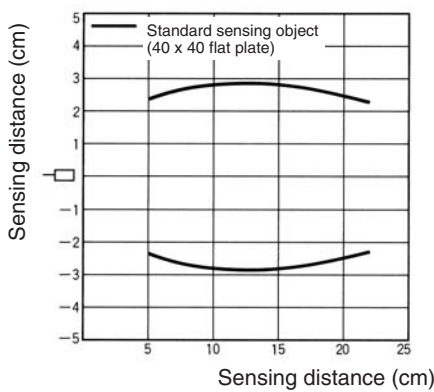

E4B-LS70E4, E4B-RS70E4

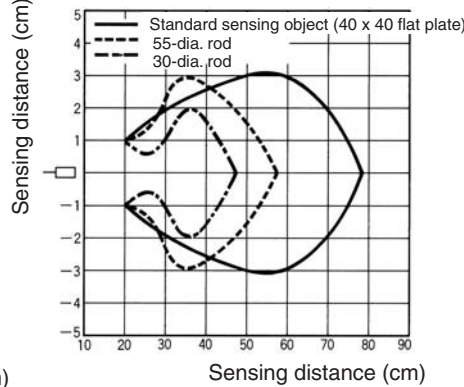

Operating Distance vs. Sensing Object Angle (Typical)

E4B-LS70E4, E4B-RS70E4

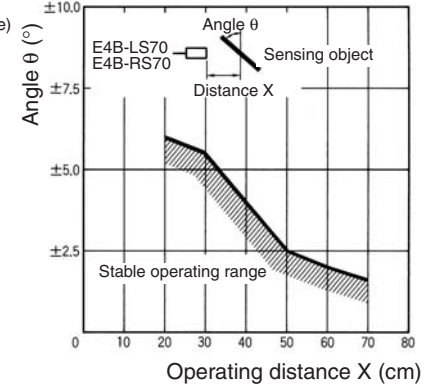

Ambient Temperature vs. Variation Rate of Sensing Distance (Typical)

E4B-LS70E4, E4B-RS70E4

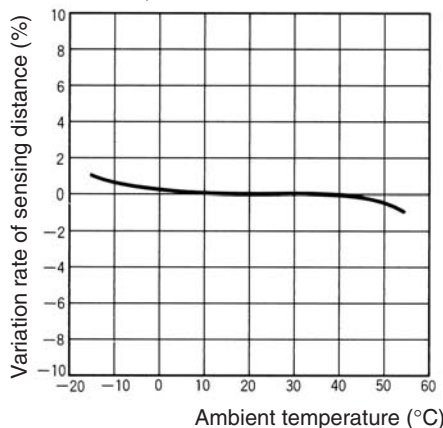

Sensitivity Adjuster Position vs. Parallel Movement Characteristics

E4B-T1E4

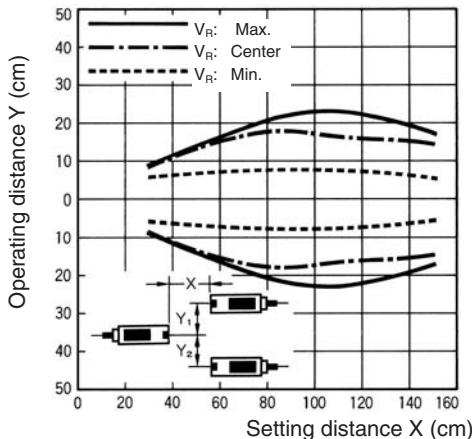

Note: Obtain the point that turns Y_1 and Y_2 ON while changing the sensing distance (X).

■ Adjustments

Indicators

1. STABILITY Indicator (Green)
When this indicator is lit, the ultrasonic input into the Receiver is sufficient, or its interruption is small enough, to ensure the smooth operation of the E4B. Do not operate the E4B when this indicator is not lit.
2. SENSING Indicator (Red)
When this indicator is lit, the Receiver has ultrasonic input.

Indicator of Through-beam Emitter

1. Incident Indicator
Lit when there is ultrasonic input.
To use this indicator of the Emitter as a SENSING indicator like the indicator on the Receiver, connect the black lead wires of the Emitter and Receiver together.

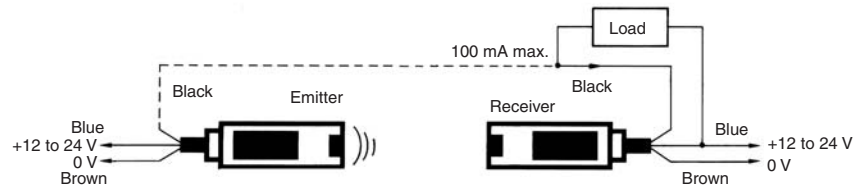

Note: Be sure not to make mistakes in polarity when connecting the above wires. In other words, both brown lead wires must connect to +DCV or 0 V and both blue lead wires must connect to 0 V or +DCV. Otherwise, the indicator of the Emitter will be lit when the ultrasonic beam is interrupted.

2. Power Indicator
Lit when the E4B is turned ON.
If the above connections are not possible (e.g., the Receiver and Emitter use different power supplies), this indicator will be used as a power indicator.

Connections of Black (White) Lead Wire of Emitter

Power connection example	Short-circuited
Brown: +DCV Blue: 0 V	0 V blue
Brown: 0 V Blue: DCV	+DCV blue

Note: The indicator will not be lit if the above wires are not connected correctly.

Beam Axis, Sensitivity, and Distance Adjustments

1. E4B-T1 and E4B-TS50 Through-beam Models

Set the SENSITIVITY adjuster of the Receiver to maximum. Move the Emitter and Receiver vertically and horizontally until the SENSING indicator of the Receiver is lit and secure the Emitter and Receiver at the midpoint of the range within which the STABILITY indicator is lit.

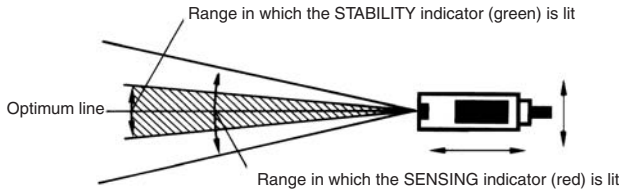

Pass the sensing object through the sensing range and adjust the sensitivity so that the SENSING indicator turns ON and OFF according to the presence or absence of the sensing object while the STABILITY indicator is lit continuously.

If the STABILITY indicator is not lit while the Sensor is in operation, this may indicate a possible operational error. Check or readjust the sensitivity.

If the Emitter and Receiver are set at a distance shorter than the rated sensing distance, reduce the sensitivity to within the range in which the STABILITY indicator is lit. This will increase the immunity of the Sensor against noise.

The parallel movement characteristics (i.e., the mutual interference distance) and sensing object size vary with the sensitivity adjustment. Refer to *Engineering Data* and make the optimum adjustments.

2. E4B-LS20* and E4B-LS70 Convergent Reflective Distance Model

Locate the Sensor so that both the STABILITY and SENSING indicators will be lit when the sensing object is placed at the sensing position, and the STABILITY indicator will be lit and the SENSING indicator will turn OFF when the sensing object is removed.

Step	1	2	3
Sensing			
Distance adjuster		---	---
Adjustment procedure	Place the sensing object at the sensing position and turn the distance adjuster clockwise gradually until both the SENSING and STABILITY indicators are lit.	Move the Emitter and Receiver vertically and horizontally and secure the Emitter and Receiver at the midpoint of the range within which the STABILITY indicator is lit.	Remove the sensing object and check that the SENSING indicator is OFF and the STABILITY indicator is continuously lit.

Note: If the STABILITY indicator is not lit while the Sensor is in operation, this indicates a possible operational error. Check or readjust the sensitivity.

Note: *E4B-LS20
The sensing distance is adjustable within a range of 10 to 20 cm with the distance adjuster.

Sensing distance	Position of distance adjuster
5 to 10 cm	Set to the position 5-20. The distance range will be 5 to 23 cm in this case due to the characteristics of the ultrasonic beam.
10 to 20 cm	The adjuster can be set freely within a range of 10 to 20 cm. The object can be detected within a range of 5 to 10 cm in this case due to multiple ultrasonic reflection.

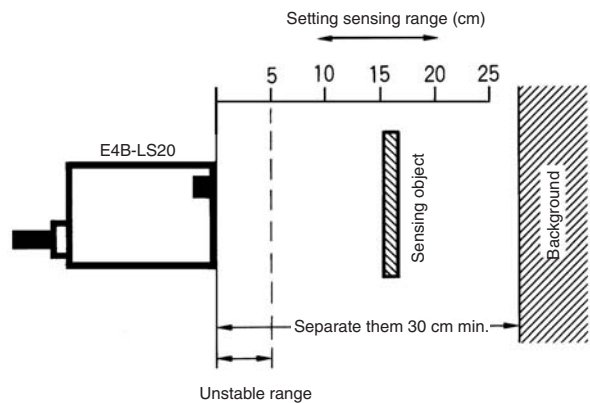

3. E4B-RS70 Convergent Reflective Zone

General Use

Locate the Sensor so that both the STABILITY and SENSING indicators will be lit when the sensing object is placed at the sensing position and the STABILITY indicator will be lit and the SENSING indicator will be off when the sensing object is removed.

Step	1	2	3
Sensing			
Distance selector		---	---
Adjustment procedure	Place the sensing object at the sensing position and turn the distance selector clockwise gradually until both the SENSING and STABILITY indicators are lit.	Move the Emitter and Receiver vertically and horizontally and secure the Emitter and Receiver at the midpoint of the range within which the STABILITY indicator is lit.	Remove the sensing object and check that the SENSING indicator is OFF and the STABILITY indicator is continuously lit.

- Note:**
1. If the STABILITY indicator is not lit while the Sensor is in operation, this indicates a possible operational error. Check or readjust the sensitivity.
 2. If the background object is within a distance of 1.5 m from the sensing head, the SENSING indicator may be lit and the STABILITY indicator may not be lit in spite of the absence of the sensing object. In such a case, give priority to the adjustment of the indicators with the sensing object located at the sensing position.

Retroreflective Use

The retroreflective model assures the stable detection of objects under irregular and unstable reflection conditions (e.g., if the sensing objects are different in surface or size, if they are passed through diagonally, or if they are warped or move in a wave-like way).

The Reflector must be at least 4 x 4 cm in size and made of a material that is efficiently reflective (such as a metal plate). The E39-R1 for photomicrosensors is ideal.

Be sure that the reflector is not set within the sensing range.

Set the distance selector to the desired position, fix the reflector around the midpoint of the set sensing range, and check that both the SENSING and STABILITY indicators are lit.

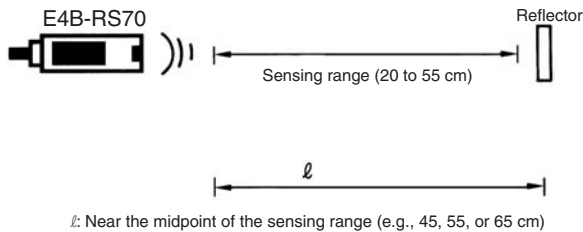

Step	1	2	3
Sensing			
Distance selector		---	---
Adjustment procedure	Set the distance selector to the desired zone position, mount the Reflector at or near the midpoint of the set zone, and confirm that both the STABILITY and SENSING indicators are lit.	Move the Emitter and Receiver vertically and horizontally and secure the Emitter and Receiver at the midpoint of the range within which the STABILITY indicator is lit.	Remove the sensing object and check that the SENSING indicator is OFF and the STABILITY indicator is continuously lit.

- Note:**
1. If the STABILITY indicator is not lit while the Sensor is in operation, this indicates a possible operational error. Check or readjust the sensitivity.
 2. If the sensing object is in position A parallel to the Reflector as shown above, the SENSING indicator may be lit and the STABILITY indicator may not be lit depending on the position of the sensing object. In such a case, give priority to the adjustment of the STABILITY indicator when the beam is incident by means of the reflector.

Operation

■ Output Circuits

NPN Models Switching DC

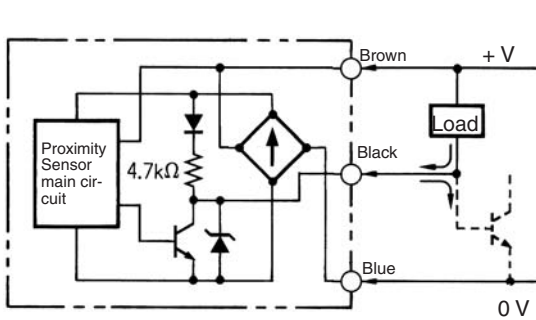

- Note:**
1. 100 mA max. (load current)
 2. Required when the transistor circuit is connected.

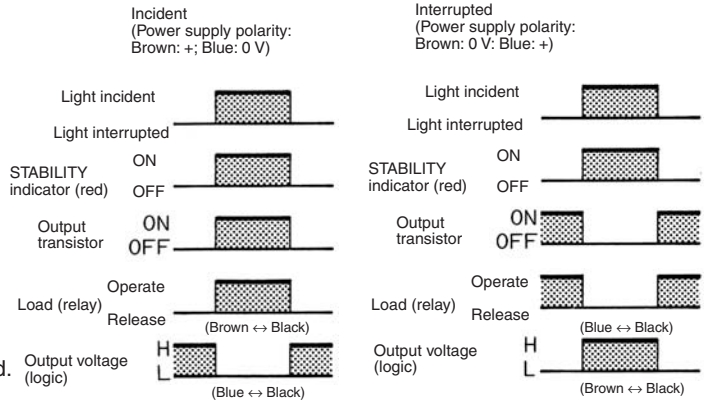

Dimensions

Note: All units are in millimeters unless otherwise indicated.

E4B-TS50
E4B-T1
E4B-LS20
E4B-LS70
E4B-RS70

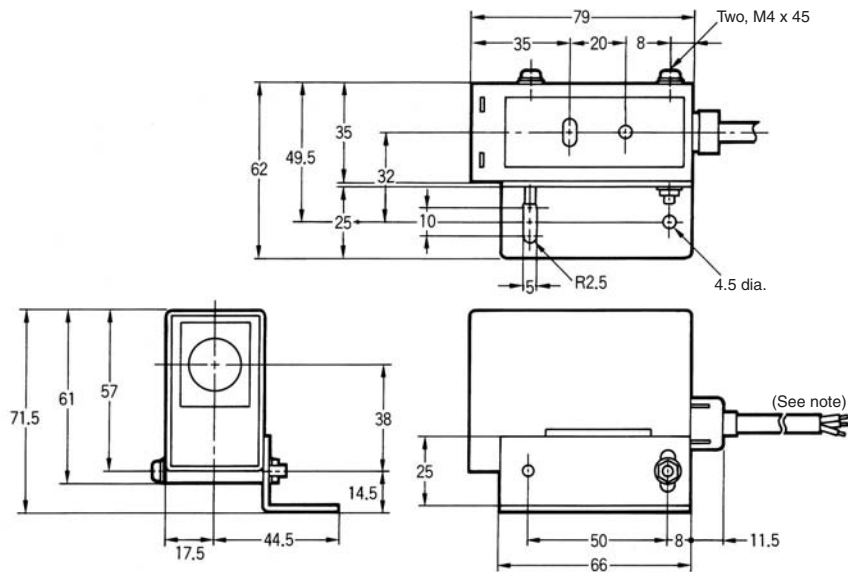
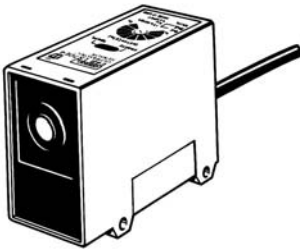

Note: Vinyl-insulated round cord with three conductors, 6 dia.; standard length: 2 m

Precautions

■ Correct Use

Sensor Mounting Angle

If the E4B is in level control or distance control of sensing objects, the stability of signal detection will depend on the sensing surface condition of the objects. Considering the repose angle of the objects, mount the E4B so that the ultrasonic beam and the sensing surface of each object meet at right angles to each other.

Surrounding Objects

Make sure that the Sensor is free from surrounding objects that reflect the ultrasonic beam diffusion, otherwise the Sensor may malfunction. In particular, pay the utmost attention so that no side lobe of the ultrasonic beam will be reflected by such objects.

Mounting

Securely mount the E4B by using the nuts provided with the E4B or the mounting holes of the E4B. Refer to *Dimensions* for details.

Do not strike the Sensor with any hammer or other object, otherwise the E4B will no longer be water-resistant.

If the E4B is not mounted securely, the E4B may be damaged by vibration or may not detect sensing objects accurately due to a possible change in the mounting position.

Environmental Conditions

Do not use the E4B at a temperature exceeding the rated range or outdoors, otherwise the reliability and life of the E4B will decrease.

The Ultrasonic Reflective Sensor utilizes the air as a beam transmission media. Do not use the E4B in places with radical convection or extreme local temperature changes. For example, if there is a hot air curtain that causes turbulence within the sensing area, the E4B may malfunction.

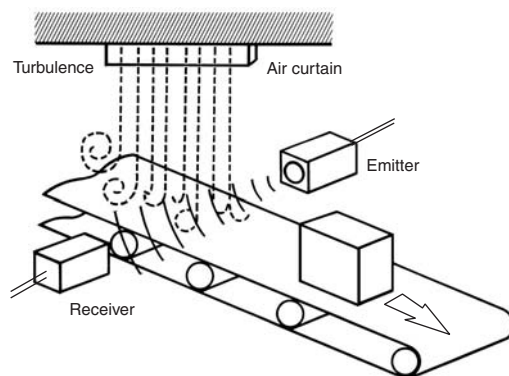

The jetting sound of air nozzles includes noise of a wide frequency range, which will affect the operation of the E4B. Do not use an air nozzle near the E4B.

The sensing distance of the E4B will decrease if there is any water drops on the surface of the emitter or receiver.

The through-beam model may not detect any objects if there is any object absorbing sound, such as powder and cotton, on the surface of the emitter or receiver.

ALL DIMENSIONS SHOWN ARE IN MILLIMETERS.

To convert millimeters into inches, multiply by 0.03937. To convert grams into ounces, multiply by 0.03527.

In the interest of product improvement, specifications are subject to change without notice.

OMRON Corporation

Industrial Automation Company

Sensing Devices Division H.Q.

Application Sensors Division

Shiokoji Horikawa, Shimogyo-ku,

Kyoto, 600-8530 Japan

Tel: (81)75-344-7068/Fax: (81)75-344-7107

Read and Understand This Catalog

Please read and understand this catalog before purchasing the products. Please consult your OMRON representative if you have any questions or comments.

Warranty and Limitations of Liability

WARRANTY

OMRON's exclusive warranty is that the products are free from defects in materials and workmanship for a period of one year (or other period if specified) from date of sale by OMRON.

OMRON MAKES NO WARRANTY OR REPRESENTATION, EXPRESS OR IMPLIED, REGARDING NON-INFRINGEMENT, MERCHANTABILITY, OR FITNESS FOR PARTICULAR PURPOSE OF THE PRODUCTS. ANY BUYER OR USER ACKNOWLEDGES THAT THE BUYER OR USER ALONE HAS DETERMINED THAT THE PRODUCTS WILL SUITABLY MEET THE REQUIREMENTS OF THEIR INTENDED USE. OMRON DISCLAIMS ALL OTHER WARRANTIES, EXPRESS OR IMPLIED.

LIMITATIONS OF LIABILITY

OMRON SHALL NOT BE RESPONSIBLE FOR SPECIAL, INDIRECT, OR CONSEQUENTIAL DAMAGES, LOSS OF PROFITS, OR COMMERCIAL LOSS IN ANY WAY CONNECTED WITH THE PRODUCTS, WHETHER SUCH CLAIM IS BASED ON CONTRACT, WARRANTY, NEGLIGENCE, OR STRICT LIABILITY.

In no event shall responsibility of OMRON for any act exceed the individual price of the product on which liability is asserted.

IN NO EVENT SHALL OMRON BE RESPONSIBLE FOR WARRANTY, REPAIR, OR OTHER CLAIMS REGARDING THE PRODUCTS UNLESS OMRON'S ANALYSIS CONFIRMS THAT THE PRODUCTS WERE PROPERLY HANDLED, STORED, INSTALLED, AND MAINTAINED AND NOT SUBJECT TO CONTAMINATION, ABUSE, MISUSE, OR INAPPROPRIATE MODIFICATION OR REPAIR.

Application Considerations

SUITABILITY FOR USE

OMRON shall not be responsible for conformity with any standards, codes, or regulations that apply to the combination of products in the customer's application or use of the product.

At the customer's request, OMRON will provide applicable third party certification documents identifying ratings and limitations of use that apply to the products. This information by itself is not sufficient for a complete determination of the suitability of the products in combination with the end product, machine, system, or other application or use.

The following are some examples of applications for which particular attention must be given. This is not intended to be an exhaustive list of all possible uses of the products, nor is it intended to imply that the uses listed may be suitable for the products:

- Outdoor use, uses involving potential chemical contamination or electrical interference, or conditions or uses not described in this catalog.
- Nuclear energy control systems, combustion systems, railroad systems, aviation systems, medical equipment, amusement machines, vehicles, safety equipment, and installations subject to separate industry or government regulations.
- Systems, machines, and equipment that could present a risk to life or property.

Please know and observe all prohibitions of use applicable to the products.

NEVER USE THE PRODUCTS FOR AN APPLICATION INVOLVING SERIOUS RISK TO LIFE OR PROPERTY WITHOUT ENSURING THAT THE SYSTEM AS A WHOLE HAS BEEN DESIGNED TO ADDRESS THE RISKS, AND THAT THE OMRON PRODUCT IS PROPERLY RATED AND INSTALLED FOR THE INTENDED USE WITHIN THE OVERALL EQUIPMENT OR SYSTEM.

Disclaimers

CHANGE IN SPECIFICATIONS

Product specifications and accessories may be changed at any time based on improvements and other reasons.

It is our practice to change model numbers when published ratings or features are changed, or when significant construction changes are made. However, some specifications of the product may be changed without any notice. When in doubt, special model numbers may be assigned to fix or establish key specifications for your application on your request. Please consult with your OMRON representative at any time to confirm actual specifications of purchased product.

DIMENSIONS AND WEIGHTS

Dimensions and weights are nominal and are not to be used for manufacturing purposes, even when tolerances are shown.

ERRORS AND OMISSIONS

The information in this catalog has been carefully checked and is believed to be accurate; however, no responsibility is assumed for clerical, typographical, or proofreading errors, or omissions.

PERFORMANCE DATA

Performance data given in this catalog is provided as a guide for the user in determining suitability and does not constitute a warranty. It may represent the result of OMRON's test conditions, and the users must correlate it to actual application requirements. Actual performance is subject to the OMRON Warranty and Limitations of Liability.

PROGRAMMABLE PRODUCTS

OMRON shall not be responsible for the user's programming of a programmable product, or any consequence thereof.

COPYRIGHT AND COPY PERMISSION

This catalog shall not be copied for sales or promotions without permission.

This catalog is protected by copyright and is intended solely for use in conjunction with the product. Please notify us before copying or reproducing this catalog in any manner, for any other purpose. If copying or transmitting this catalog to another, please copy or transmit it in its entirety.