

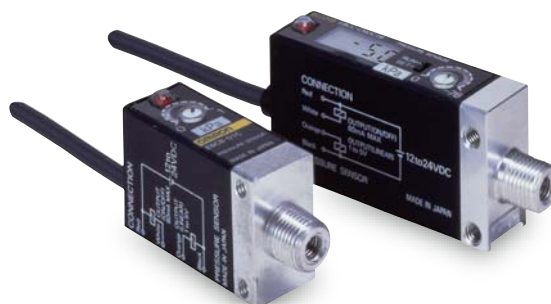

Slim Digital Pressure Sensor

E8CB/E8CC

E8CC with Built-in Microcomputer and Digital Display

- Withstands a pressure of 490 kPa and highly reliable.
- Incorporates a two-turn pressure adjuster ensuring easy pressure setting.



 Be sure to read *Safety Precautions* on page 5.

Ordering Information

Digital display	Pressure range		ON/OFF output	Linear output	Model
No	Positive pressure	0 to 100 kPa	NPN open collector	1 to 5 V	E8CB-01C
	Negative pressure	0 to -100 kPa			E8CB-CN0C2B
Yes	Positive pressure	0 to 98 kPa			E8CC-A01C
	Negative pressure	0 to -101 kPa			E8CC-AN0C
	Positive pressure	0 to 980 kPa			E8CC-B10C

Ratings and Specifications

Item	Model	E8CB-01C	E8CB-CN0C2B*	E8CC-A01C	E8CC-AN0C*	E8CC-B10C
Power supply voltage		12 to 24 VDC $\pm 10\%$ with a ripple (p-p) of 5% max.				
Current consumption		20 mA max.		30 mA max.		
Pressure type		Gauge pressure				
Permissible pressure range		0 to 100 kPa	0 to -100 kPa	0 to 98 kPa	0 to -101 kPa	0 to 980 kPa
Pressure setting range		0 to 100 kPa	0 to -100 kPa	0 to 98 kPa	0 to -101 kPa	0 to 980 kPa
Pressure indication unit		---		kPa		
Withstand pressure		490 kPa				1.5 MPa
Applicable material		Noncorrosive and nonflammable gases				
Repeat accuracy (ON/OFF output)		$\pm 1\%$ FS max.				
Accuracy (linear output)		$\pm 3\%$ FS max.				
Differential travel (ON/OFF output)		2% FS max.				
Linearity (linear output)		$\pm 1\%$ FS max.				
Response time		5 ms max.				
Linear output		1 to 5 V with an output impedance of 20 Ω and a permissible resistive load of 10 k Ω min.				
ON/OFF output		NPN open collector				
	Load current	80 mA max.				
	Output applied voltage	30 VDC max.				
	Residual voltage	1 V max. (with a load current of 80 mA) and 0.4 V max. (with a load current of 20 mA)				
Protection circuits		Reversed power supply connection and load short-circuiting				
Display (See note.)		Operation indicator (red)		2 ¹ / ₂ -digit LCD, operation indicator (red)		
Display accuracy		---		$\pm 3\%$ FS ± 1 digit max. (within a temperature range between 0°C and 50°C) $\pm 4\%$ FS ± 1 digit max. (within a temperature range between 50°C and 55°C) $\pm 5\%$ FS ± 1 digit max. (within a temperature range between -10°C and 0°C)		
Ambient temperature		Operating: -10°C to 55°C (with no icing) Storage: -25°C to 70°C (with no icing)				
Ambient humidity		Operating/Storage: 35% to 95% (with no condensation)				
Temperature influence		$\pm 0.12\%$ FS/°C between 0°C and 50°C and $\pm 0.2\%$ FS/°C max. between -10°C and 0°C or 50°C and 55°C				
Voltage influence		$\pm 1.5\%$ FS max.				
Insulation resistance		50 M Ω min. (at 500 VDC) between current carrying parts and case				
Dielectric strength		1,000 VAC for 1 min				
Vibration resistance (destruction)		10 to 500 Hz, 1.5-mm double amplitude or 100 m/s ² for 2 hours each in X, Y, and Z directions				
Shock resistance (destruction)		1,000 m/s ² 3 times each in X, Y, and Z directions				
Degree of protection		IEC 60529 IP50				
Pressure inlet		R(PT)1/8, and M5 female screw				
Connection method		Pre-wired (Standard cable length: 2 m)				
Weight (packed state)		Approx. 70 g		Approx. 80 g		
Material	Pressure port	Aluminum				
Accessories		Instruction manual		Instruction manual, DIN track mounting bracket		

Note: An example of a 2¹/₂-digit display is shown below.

	Rated pressure range	Digital display		
		3rd digit	2nd digit	1st digit
Positive pressure	0 to 98 kPa		9	8
	0 to 980 kPa		9	8
Negative pressure	0 to -101 kPa	---	1	0

Note: The display values shown above are for when the maximum rated pressure is applied.

* These models are negative-pressure models.

Engineering Data (Typical)

Linear Output Fluctuation vs. Temperature

E8CB-01C

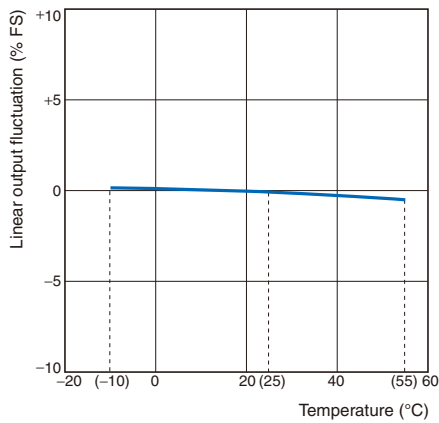

E8CC-A01C

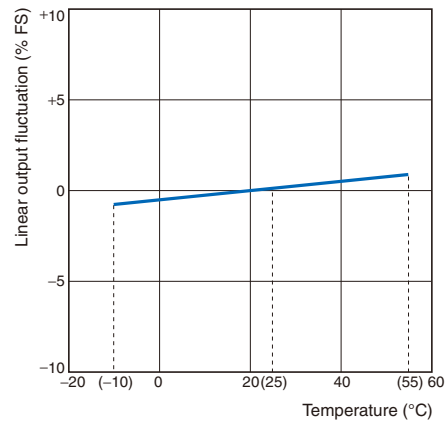

Linear Output Voltage vs. Pressure

E8CB-01C

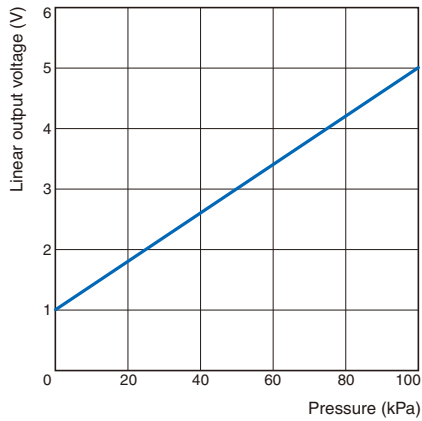

E8CC-A01C

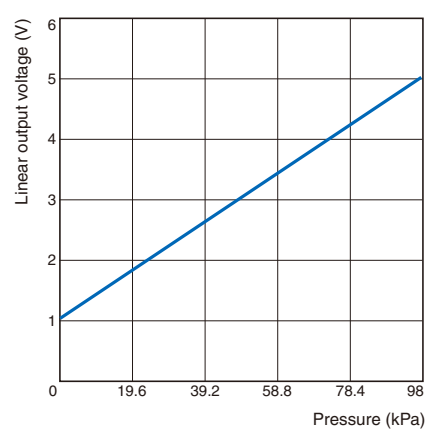

Operating Pressure vs. Temperature

E8CB-01C

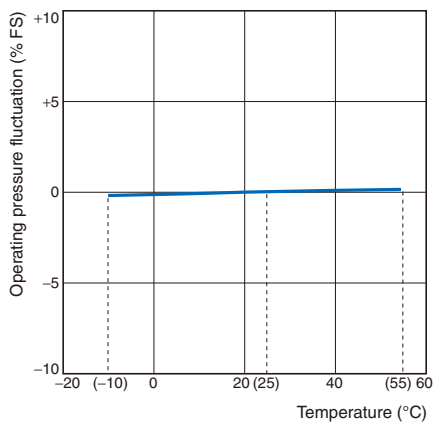

E8CC-A01C

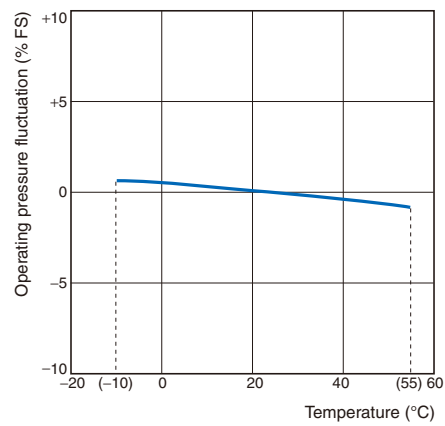

Linearity

E8CB-01C

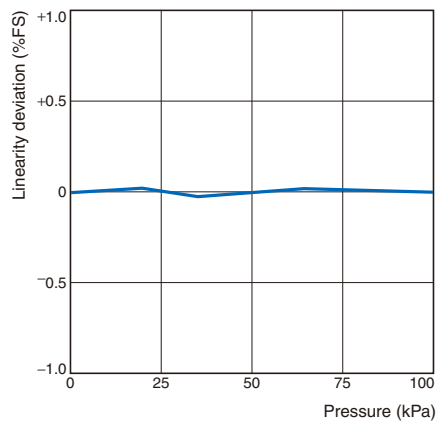

E8CC-A01C

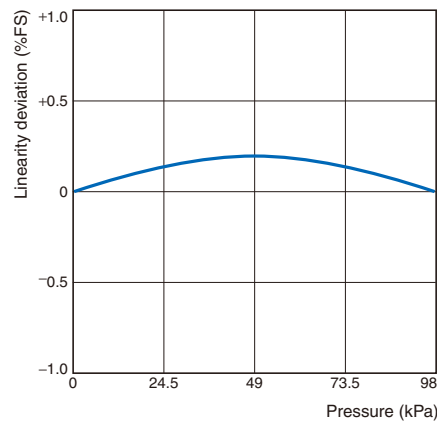

Operating Pressure Fluctuation vs. Voltage

E8CB-01C

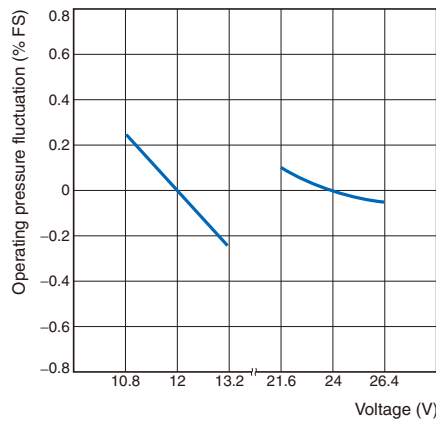

E8CC-AN0C

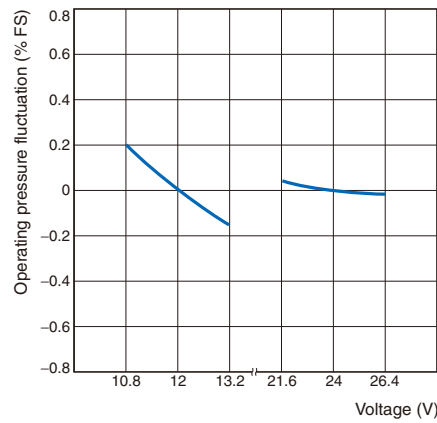

Linear Output Fluctuation vs. Voltage

E8CB-01C

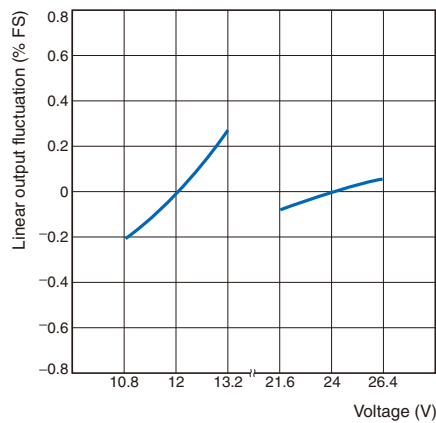

E8CC-AN0C

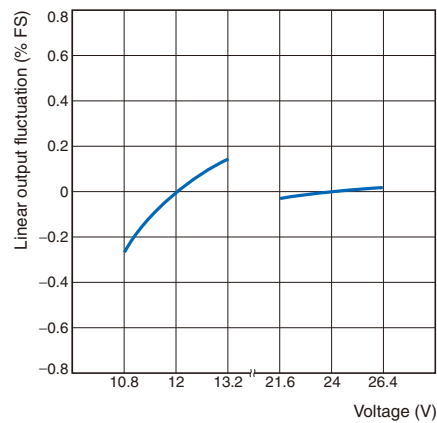

I/O Circuit Diagrams

NPN Output

Model	Timing Charts	Output Circuits
E8CB-01C E8CC-A01C E8CC-B10C		
E8CB-CN0C2B E8CC-AN0C		

Safety Precautions

WARNING

This product is not designed or rated for ensuring safety of persons. Do not use it for such purposes.



Precautions for Correct Use

Do not use the product in atmospheres or environments that exceed product ratings.

● Mounting

Diaphragm

- If the diaphragm is damaged, the Pressure Sensor will not operate properly. Do not insert a screwdriver or steel wire into the interior of the pressure-sensitive parts through the pressure inlet.

Mounting

- The pressure inlet has an R (PT)1/8 taper screw and an M5 female screw. Apply sealing tape around a screw that conforms to JIS Standards so that no pressure leakage will occur.
- Do not apply a tightening torque higher than 3.9 N·m.
- If the Pressure Sensor is directly connected to a conduit, be sure to apply a wrench to the pressure inlet. Do not apply the wrench to the plastic case.

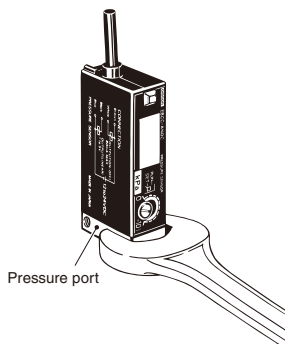

DIN Track Mounting Bracket (E8CC)

● Mounting

1. Fit the front part onto the bracket.
2. Press the rear part onto the bracket.

● Removing

3. Apply a flat-blade screwdriver to the rear hook. Then the Pressure Sensor can be removed with ease.

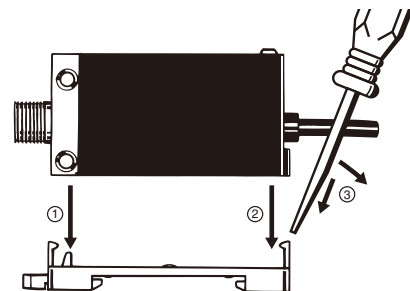

DIN track mounting bracket

● Wiring

- If no linear output is used, cut off the black lead wire and apply insulation tape to the lead wire so that it will not come in contact with any other terminal.

● Adjustment

Setting the Pressure on the E8CC

1. Set the mode selector to SET.



2. Turn the pressure adjuster to the desired pressure.

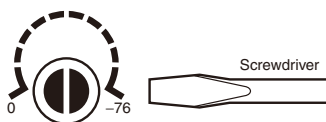

3. Set the mode selector to RUN.



The E8CC has, however, normal output in SET mode. Change in pressure setting is possible in RUN mode by turning the pressure adjuster. Do not turn the pressure adjuster after the pressure adjuster has been set to the desired pressure.

Indications

Display	Mode	Operating status	Description	Permissible range		
				Positive pressure		Negative pressure
				E8CC -A01C	E8CC -B10C	E8CC -AN0C
30 (for 30 kPa)	RUN	Normal	Displays the imposed pressure within the permissible range.	0 to 98 kPa	0 to 980 kPa	0 to -101 kPa
	SET	Normal	Displays the ON-point setting pressure within the permissible range			
--	RUN	Abnormal pressure imposition	<ul style="list-style-type: none"> Positive Pressure: Indicates that the imposed pressure is lower than the permissible range. Negative Pressure: Indicates that the imposed pressure is higher than the permissible range. The E8CC is, however, in normal output operation in both cases. 	0 to 98 kPa	0 to 980 kPa	0 to -101 kPa
	SET	Abnormal pressure setting	<ul style="list-style-type: none"> Positive Pressure: Indicates that ON-point setting pressure value is lower than the permissible range. Negative Pressure: Indicates that ON-point setting pressure is higher than the permissible range. The E8CC is, however, in normal output operation in both cases. 			
FF	RUN	Abnormal pressure imposition	Indicates that the imposed pressure is higher than the permissible range.	0 to 98 kPa	0 to 980 kPa	---
	SET	Abnormal pressure setting	<ul style="list-style-type: none"> Positive Pressure: Indicates that ON-point setting pressure value is higher than the permissible range. Negative Pressure: Indicates that ON-point setting pressure is lower than the permissible range. The E8CC is, however, in normal output operation in both cases. 			0 to -101 kPa
LE	RUN	Load over-current	Indicates that the output transistor has excessive load current, in which case, the output of the E8CC is turned OFF and this display flashes until the condition returns to normal. Check the output wiring if this display flashes.	0 to 98 kPa	0 to 980 kPa	0 to -101 kPa
	SET					
SH	RUN	Element destruction	Indicates that the Pressure Sensor element is damaged due to the imposition of excessive pressure or other reasons, in which case, the output of the E8CC is turned OFF. If this display appears, the E8CC can no longer be used.	0 to 98 kPa	0 to 980 kPa	0 to -101 kPa
	SET					

Dimensions

E8CB

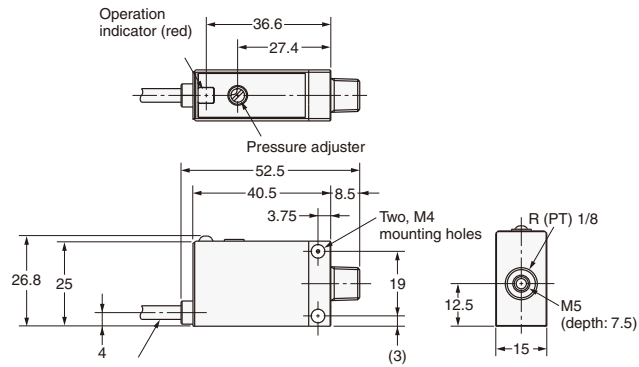
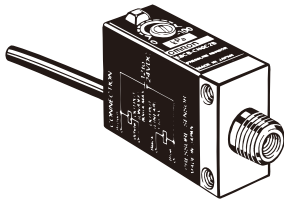

4-dia. vinyl-insulated round cable with 4 conductor,
(Conductor cross-section: 0.2 mm², Insulator diameter: 1.1 mm);
Standard length: 2 m

E8CC

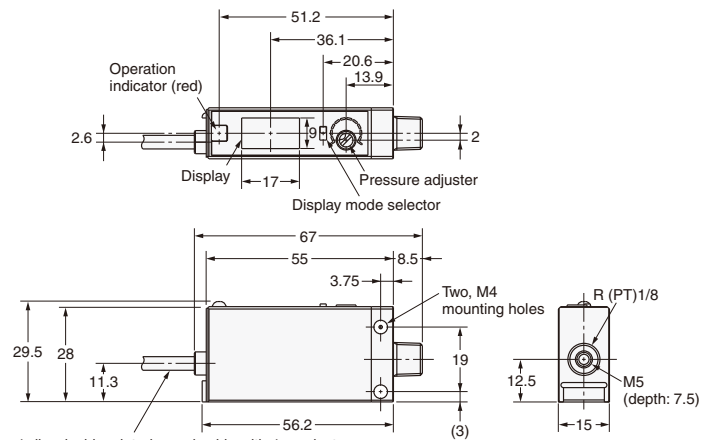
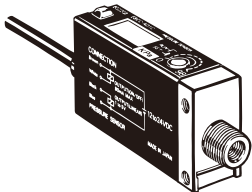

4-dia. vinyl-insulated round cable with 4 conductors,
(Conductor cross-section: 0.2 mm², Insulator diameter: 1.1 mm); Standard length: 2 m

Mounted to a DIN Track Mounting Bracket

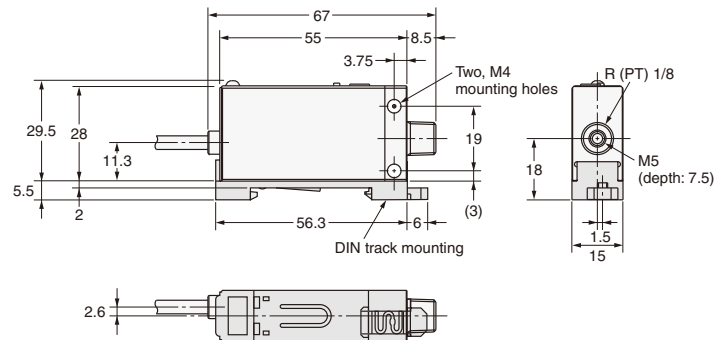
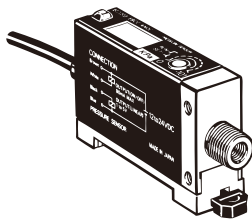

Output Impedance

1. Measuring the Output Impedance of Voltage Output

Models

Figure 1

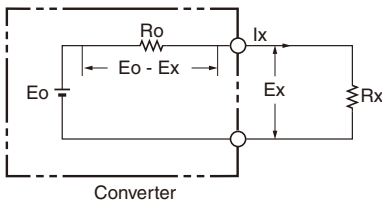

- Ro : Output impedance
- Rx : Load resistance
- Eo : Output voltage (terminals open)
- Ex : Output voltage (with load Rx connected)
- Ix : Load current (with load Rx connected)

In Figure 1, the current (Ix) that flows when the load resistance (Rx) is connected is calculated as follows:

$$I_x = \frac{E_x}{R_x} = \frac{E_o - E_x}{R_o} \dots\dots(1)$$

The output impedance (Ro) in Equation (1) is calculated as follows:

$$R_o = R_x \left(\frac{E_o - E_x}{E_x} \right) \dots\dots(2)$$

The voltage (Eo) is measured when the output is open, followed by the voltage (Ex) when a load resistance (for example, the minimum value of the permitted load resistance of a transducer) is connected. The measured values Eo and Ex and the connected load resistance (Rx) are inserted into Equation 2 to calculate the output impedance (Ro) of the transducer.

2. Measuring the Output Impedance of Current Output

Models

In Figure 2, the voltage (Ex) of the output terminals when the load resistance (Rx) is connected is calculated as follows:

$$E_x = I_x R_x = (I_o - I_x) R_o \dots\dots(3)$$

The output impedance in Equation (3) is calculated as follows:

$$R_o = R_x \left(\frac{I_x}{I_o - I_x} \right) \dots\dots(4)$$

Here, the current (Io) is measured with the output short-circuited.

Figure 2

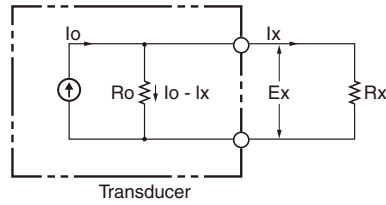

- Ro : Output impedance
- Rx : Load resistance
- Io : Output current (output terminal short-circuited)
- Ix : Output current (with load Rx connected)
- Ex : Output voltage (with load Rx connected)

Next, the output current (Ix) is measured when a load resistance (for example, the maximum value of the permitted load resistance of a transducer) is connected. The measured values Io and Ix and the value of the connected load resistance (Rx) are inserted into Equation 4, and the output impedance (Ro) of the transducer is calculated. The output impedance of the transducer introduced here is the value for normal operation.

3. Desirable Output Impedance

In general, it is best to make the output impedance of a voltage output transducer as small as possible, i.e., as close to 0 W as possible, to minimize the effects of load fluctuations on the transducer. For a current output transducer, the opposite is true: the higher the impedance (the closer to infinite impedance), the better.

4. Example of Calculation Using Impedance

$$\text{Error in analog voltage output} = \left(1 - \frac{R_x}{R_o + R_x} \right) \times 100\%$$

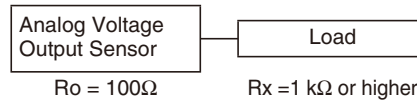

Rx	Error
1kΩ	Approximately 10%
10Ω	Approximately 1%

General Precautions For precautions on individual products, refer to the *Safety Precautions* in the individual product information.

WARNING

These products cannot be used in safety devices for presses or other safety devices used to protect human life. These products are designed for use in applications for sensing workpieces and workers that do not affect safety.



Precautions for Safe Use

Withstand Pressure

Do not apply a pressure higher than the rated withstand pressure. Applying a pressure higher than this may cause damage.

Operating Environment

Do not use the products in an environment where there are explosive or inflammable gases.

Power Supply Voltage

Do not use a voltage that exceeds the power supply voltage range. Using a voltage that exceeds the range may cause burning.

Load Short-circuiting

Do not short-circuit the load. Doing so may cause explosion or burning.

Incorrect Wiring

Be sure that the power supply polarity and other wiring is correct. Incorrect wiring may cause explosion or burning.

Precautions for Correct Use

- When using a Sensor that supports non-corrosive gas as the applicable fluid, use an air filter to remove moisture and oil from the gas.
- Do not insert any wire or other object into the pressure port. Doing so may damage the pressure elements and cause a malfunction.
- Do not use the Sensor alongside high-voltage lines or power lines.
- Mount the Sensor so that it is not subject to ultrasonic vibration.
- Do not apply a tensile force higher than 30 N to the cable or connector.
- The cable can be extended to a maximum of 10 m. For details, see the output impedance section on the previous page.

Read and Understand This Catalog

Please read and understand this catalog before purchasing the products. Please consult your OMRON representative if you have any questions or comments.

Warranty and Limitations of Liability

WARRANTY

OMRON's exclusive warranty is that the products are free from defects in materials and workmanship for a period of one year (or other period if specified) from date of sale by OMRON.

OMRON MAKES NO WARRANTY OR REPRESENTATION, EXPRESS OR IMPLIED, REGARDING NON-INFRINGEMENT, MERCHANTABILITY, OR FITNESS FOR PARTICULAR PURPOSE OF THE PRODUCTS. ANY BUYER OR USER ACKNOWLEDGES THAT THE BUYER OR USER ALONE HAS DETERMINED THAT THE PRODUCTS WILL SUITABLY MEET THE REQUIREMENTS OF THEIR INTENDED USE. OMRON DISCLAIMS ALL OTHER WARRANTIES, EXPRESS OR IMPLIED.

LIMITATIONS OF LIABILITY

OMRON SHALL NOT BE RESPONSIBLE FOR SPECIAL, INDIRECT, OR CONSEQUENTIAL DAMAGES, LOSS OF PROFITS, OR COMMERCIAL LOSS IN ANY WAY CONNECTED WITH THE PRODUCTS, WHETHER SUCH CLAIM IS BASED ON CONTRACT, WARRANTY, NEGLIGENCE, OR STRICT LIABILITY.

In no event shall responsibility of OMRON for any act exceed the individual price of the product on which liability is asserted.

IN NO EVENT SHALL OMRON BE RESPONSIBLE FOR WARRANTY, REPAIR, OR OTHER CLAIMS REGARDING THE PRODUCTS UNLESS OMRON'S ANALYSIS CONFIRMS THAT THE PRODUCTS WERE PROPERLY HANDLED, STORED, INSTALLED, AND MAINTAINED AND NOT SUBJECT TO CONTAMINATION, ABUSE, MISUSE, OR INAPPROPRIATE MODIFICATION OR REPAIR.

Application Considerations

SUITABILITY FOR USE

OMRON shall not be responsible for conformity with any standards, codes, or regulations that apply to the combination of products in the customer's application or use of the product.

At the customer's request, OMRON will provide applicable third party certification documents identifying ratings and limitations of use that apply to the products. This information by itself is not sufficient for a complete determination of the suitability of the products in combination with the end product, machine, system, or other application or use.

The following are some examples of applications for which particular attention must be given. This is not intended to be an exhaustive list of all possible uses of the products, nor is it intended to imply that the uses listed may be suitable for the products:

- Outdoor use, uses involving potential chemical contamination or electrical interference, or conditions or uses not described in this catalog.
- Nuclear energy control systems, combustion systems, railroad systems, aviation systems, medical equipment, amusement machines, vehicles, safety equipment, and installations subject to separate industry or government regulations.
- Systems, machines, and equipment that could present a risk to life or property.

Please know and observe all prohibitions of use applicable to the products.

NEVER USE THE PRODUCTS FOR AN APPLICATION INVOLVING SERIOUS RISK TO LIFE OR PROPERTY WITHOUT ENSURING THAT THE SYSTEM AS A WHOLE HAS BEEN DESIGNED TO ADDRESS THE RISKS, AND THAT THE OMRON PRODUCT IS PROPERLY RATED AND INSTALLED FOR THE INTENDED USE WITHIN THE OVERALL EQUIPMENT OR SYSTEM.

Disclaimers

CHANGE IN SPECIFICATIONS

Product specifications and accessories may be changed at any time based on improvements and other reasons.

It is our practice to change model numbers when published ratings or features are changed, or when significant construction changes are made. However, some specifications of the product may be changed without any notice. When in doubt, special model numbers may be assigned to fix or establish key specifications for your application on your request. Please consult with your OMRON representative at any time to confirm actual specifications of purchased product.

DIMENSIONS AND WEIGHTS

Dimensions and weights are nominal and are not to be used for manufacturing purposes, even when tolerances are shown.

ERRORS AND OMISSIONS

The information in this catalog has been carefully checked and is believed to be accurate; however, no responsibility is assumed for clerical, typographical, or proofreading errors, or omissions.

PERFORMANCE DATA

Performance data given in this catalog is provided as a guide for the user in determining suitability and does not constitute a warranty. It may represent the result of OMRON's test conditions, and the users must correlate it to actual application requirements. Actual performance is subject to the OMRON Warranty and Limitations of Liability.

PROGRAMMABLE PRODUCTS

OMRON shall not be responsible for the user's programming of a programmable product, or any consequence thereof.

COPYRIGHT AND COPY PERMISSION

This catalog shall not be copied for sales or promotions without permission.

This catalog is protected by copyright and is intended solely for use in conjunction with the product. Please notify us before copying or reproducing this catalog in any manner, for any other purpose. If copying or transmitting this catalog to another, please copy or transmit it in its entirety.