

## Solid-state Relay

G3S/G3SD

### Ultra-small Relay Breaks up to 1 A

- Ultra-small, dual in-line package (DIP) SSR.
- Terminals compatible with G6B Electromagnetic Relay's. Mix with G6Bs as the application requires.
- Close side-by-side mounting possible. In addition, heat sink dedicated to this mounting style also available.
- Both AC- and DC-load versions available.
- High isolation of 2,500 VAC between input and output freeing inputs from noise surge generated in the load.
- Built-in varistor effectively absorbs external surges. (In case of SSR for AC switching.)
- Approved by UL and CSA.

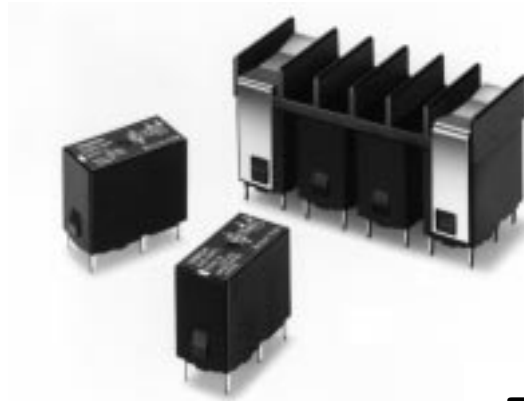

### Ordering Information

Isolation	Zero cross function	Indicator	Rated output load (applicable output load)	Rated input voltage	Model
Phototriac	No	No	1 A at 100 to 240 VAC (1 A at 75 to 264 VAC) (see note 1)	5 VDC	G3S-201PL-US
				12 VDC	
				24 VDC	
			1.2 A at 100 to 240 VAC (1.2 A at 75 to 264 VAC) (see note 1)	5 VDC	G3S-201PL-PD-US
				12 VDC	
				24 VDC	
Photocoupler			1 A at 4 to 24 VDC (1 A at 3 to 26 VDC) (see note 2)	5 VDC	G3SD-Z01P-US
				12 VDC	
				24 VDC	
			1.1 A at 4 to 24 VDC (1.1 A at 3 to 26 VDC) (see note 2)	5 VDC	G3SD-Z01P-PD-US
				12 VDC	
				24 VDC	

**Note:** 1. Product is labelled "250 VAC".

2. Product is labelled "24 VDC".

### ■ Accessories (Order Separately)

#### Heat Sink

Heat Sink	Y92B-S08N
-----------	-----------

See *Dimensions* for details.

#### Connecting Socket

Connecting Socket	P6B-04P
-------------------	---------

See *Dimensions* for details.

# Specifications

## ■ Ratings

### Input

Rated voltage	Operating voltage	Impedance		Voltage level	
		G3S-201PL/201PL-PD	G3S-Z01P/Z01P-PD	Must operate voltage	Must release voltage
5 VDC	4 to 6 VDC	450 $\Omega$ ±20%	630 $\Omega$ ±20%	4 VDC max.	1 VDC min.
12 VDC	9.6 to 14.4 VDC	1.1 k $\Omega$ ±20%	1.5 k $\Omega$ ±20%	9.6 VDC max.	
24 VDC	19.2 to 28.8 VDC	2.2 k $\Omega$ ±20%	2.8 k $\Omega$ ±20%	19.2 VDC max.	

**Note:** Each models has 5-VDC, 12-VDC, and 24-VDC input versions.

### Output

Model	Applicable load			
	Rated load voltage	Rated load voltage range	Load current	Inrush current
G3S-201PL	100 to 240 VAC	75 to 264 VAC	0.1 to 1 A	15 A (60 Hz, 1 cycle)
G3S-201PL-PD			0.1 to 1.2 A	
G3SD-Z01P	4 to 24 VDC	3 to 26 VDC	0.01 to 1 A	3 A (10 ms)
G3SD-Z01P-PD			0.01 to 1.1 A	

## ■ Characteristics

Item	G3S-201PL/201PL-PD	G3SD-Z01P/Z01P-PD
Operate time	1 ms max.	
Release time	1/2 of load power source cycle + 1 ms max.	1 ms max.
Output ON voltage drop	1.6 V (RMS) max.	1.5 V max.
Leakage current	2 mA max.	0.1 mA max. (at 26 VDC)
Insulation resistance	100 M $\Omega$ min. (at 500 VDC)	
Dielectric strength	2,500 VAC, 50/60 Hz for 1 min	
Vibration resistance	Malfunction: 10 to 55 Hz, 1.5-mm double amplitude	
Shock resistance	Malfunction: 1,000 m/s <sup>2</sup>	
Ambient temperature	Operating: -30°C to 80°C (with no icing or condensation) Storage: -30°C to 100°C (with no icing or condensation)	
Ambient humidity	Operating: 45% to 85%	
Approved standards	UL508 File No. E64562/CSA C22.2 (No.0, No.14) File No. LR35535	
Weight	Approx. 13 g	

# Engineering Data

## Load Current vs. Ambient Temperature Characteristics

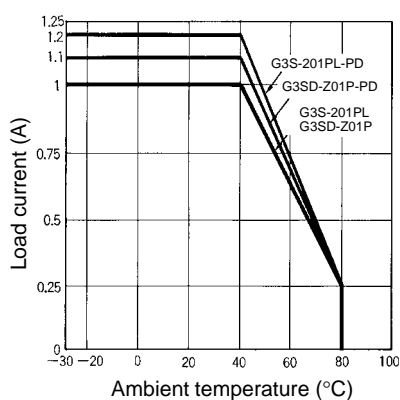

## Inrush Current Resistivity

Non-repetitive (Keep the inrush current to half the rated value if it occurs repetitively.)

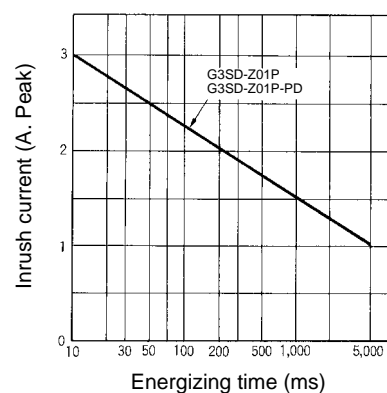
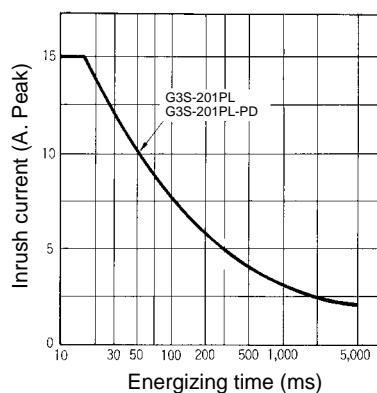

# Dimensions

Note: All units are in millimeters unless otherwise indicated.

## G3S/G3SD

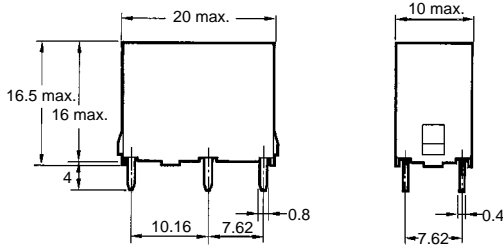
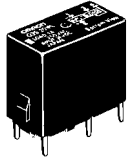

### PCB Dimensions (Bottom View)

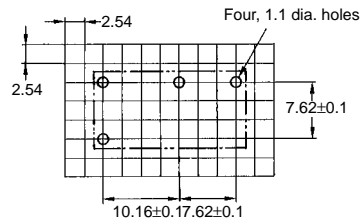

### Terminal Arrangement/ Internal Connections (Bottom View)

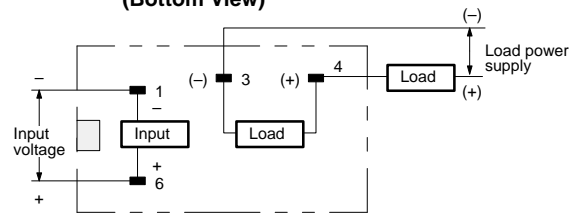

Note: Values in parentheses apply to the DC-load versions.

## Connecting Socket P6B-04P

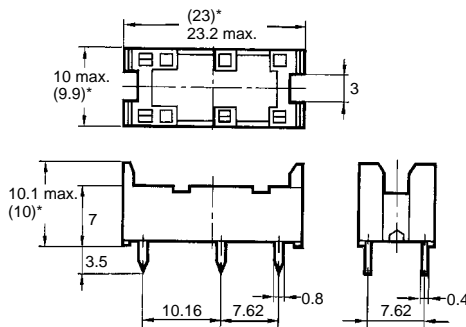
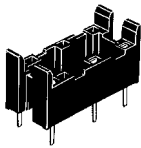

### PCB Dimensions (Bottom View)

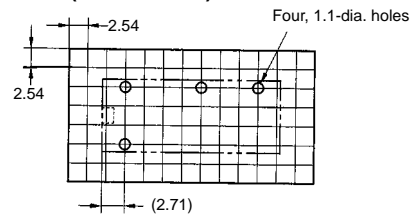

\*Average value

## Heat Sink Y92B-S08N

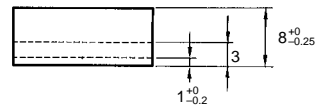
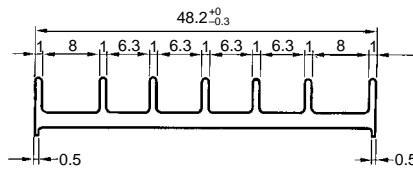
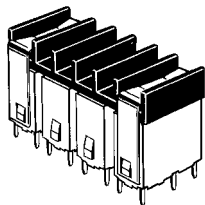

### Mounting Bracket

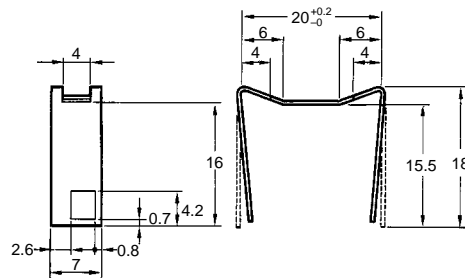

### PCB Dimensions (Bottom View)

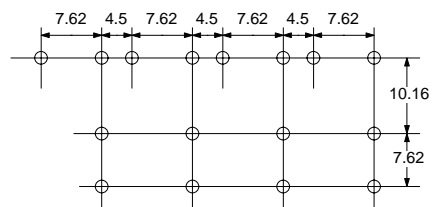

## Precautions

Refer to pages 11 to 19 for general precautions.

### Close Mounting

G3S-201PL-PD and G3SD-Z01-PD SSRs can be closely mounted side by side. Attach the Y92B-S08N Heat Sink to the SSRs mounted closely side by side. When these SSRs are mounted side by side, the load current vs. ambient temperature characteristic declines as shown on the right.

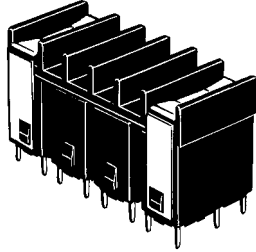

### Load Current vs. Ambient Temperature Characteristics

(When four SSRs are mounted side by side and each of them is switched to the same load current.)

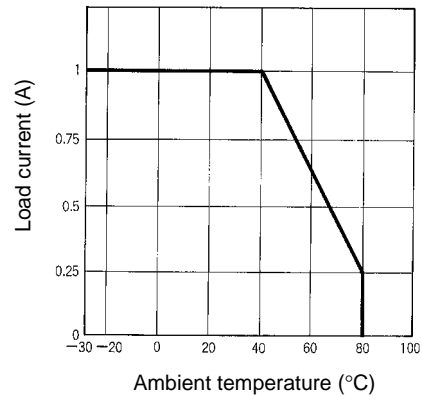

### Connection

With the SSR for DC switching, the load can be connected to either positive or negative output terminal of the SSR.

### Protective Component

Since the SSR does not incorporate an overvoltage absorption component, be sure to connect an overvoltage absorption component when using the SSR under an inductive load.

**ALL DIMENSIONS SHOWN ARE IN MILLIMETERS.**

To convert millimeters into inches, multiply by 0.03937. To convert grams into ounces, multiply by 0.03527.