

MOS FET Relay

G3RZ

SSR Identical to the G2R in Size with a Maximum AC/DC Switching Current of 1 A

- Switching 1 A at 240 VAC or 100 VDC.
- 10- μ A current leakage max. between open output terminals.
- 2,500-VAC dielectric strength ensured between input and output terminals.
- Input resistor and varistor incorporated.
- Switching full- and half-wave rectified alternating currents.



Ordering Information

Contact form	Insulation	Zero cross function	Indicator	Rated output load (applicable output load)	Rated input voltage	Model
SPST-NO	Photo-voltage coupler	No	Yes	1.0 A at 5 to 240 VAC (3 to 264 VAC) 5 to 100 VDC (3 to 125 VDC)	5 VDC 12 VDC 24 VDC	G3RZ-201SLN

■ Accessories (Order Separately)

The height of the G3RZ mounted to the P2RF-05 is 56 mm maximum.

Connecting Socket	P2RF-05, P2RF-05-E, P2R-05P, P2R-05A, P2R-057P
--------------------------	--

Connecting Socket Attaching Plate

Model	Applicable Socket
P2R-P	P2R-05A

Specifications

■ Ratings

Input

Rated voltage	Operating voltage	Input impedance	Must operate voltage	Must release voltage
5 VDC	4 to 6 VDC	400 Ω ±20%	4 VDC max.	1 VDC min.
12 VDC	9.6 to 14.4 VDC	1.1 k Ω ±20%	9.6 VDC max.	
24 VDC	19.2 to 28.8 VDC	2.2 k Ω ±20%	19.2 VDC max.	

Output

Load voltage	Load current	Inrush current
3 to 264 VAC, 3 to 125 VDC	100 μ A to 1.0 A	10 A (10 ms)

■ Characteristics

Operate time	6 ms max.
Release time	10 ms max.
Output ON-resistance	2.4 Ω max.
Leakage current	10 μ A max. (at 125 VDC)
Insulation resistance	100 M Ω min. (at 500 VDC)
Dielectric strength	2,500 VAC, 50/60 Hz for 1 min between input and output
Vibration resistance	Malfunction: 10 to 55 Hz, 1.5-mm double amplitude
Shock resistance	Malfunction: 1,000 m/s ²
Ambient temperature	Operating: -30°C to 85°C (with no icing or condensation) Storage: -30°C to 100°C (with no icing or condensation)
Ambient humidity	Operating: 45% to 85%
Weight	Approx. 20 g

Engineering Data

Load Current vs. Ambient Temperature Characteristics

G3RZ-201SLN

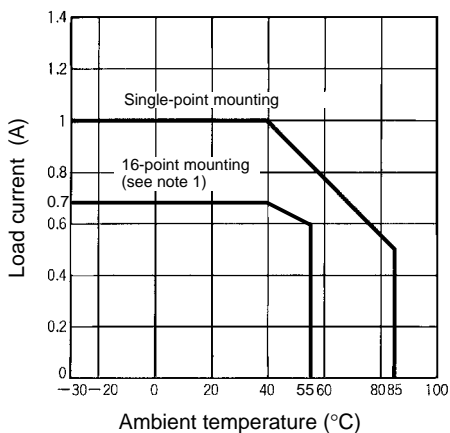

Inrush Current Resistivity

Non-repetitive (Keep the inrush current to half the rated value if it occurs repetitively.)

G3RZ-201SLN

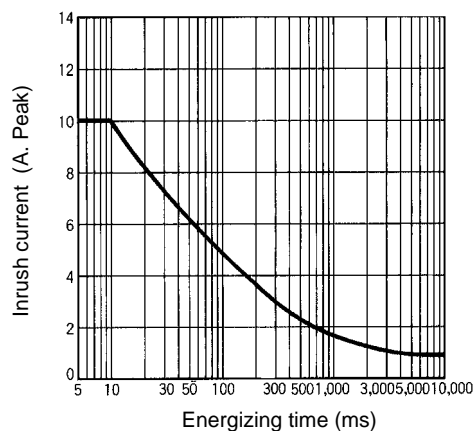

Note: 1. When G70A-ZOC16 is mounted. The description of G70A I/O Block Base is on page 210 to 212.

Dimensions

Note: All units are in millimeters unless otherwise indicated.

G3RZ-201SLN

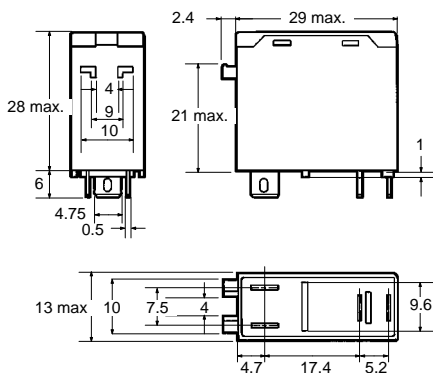
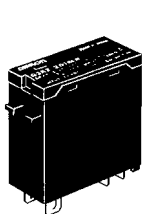

Terminal Arrangement/ Internal Connections (Bottom View)

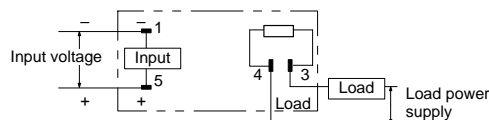

Connecting Sockets

P2RF-05

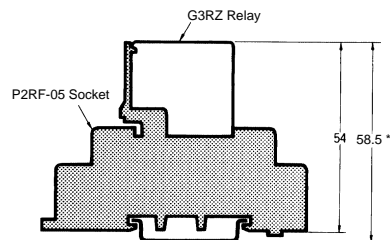
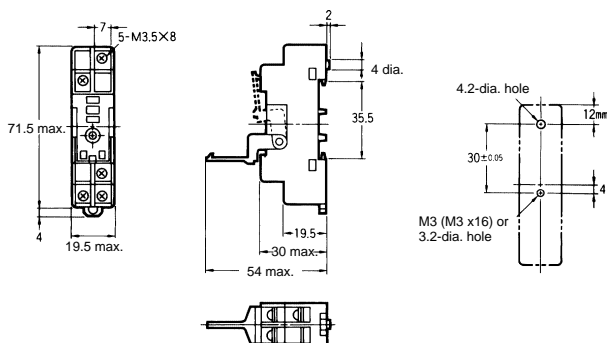
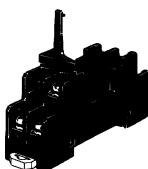

* Indicates a value when using the PFP-□N Supporting Rail. The value is 67.5 when using the PFP-□N2.

P2RF-05-E

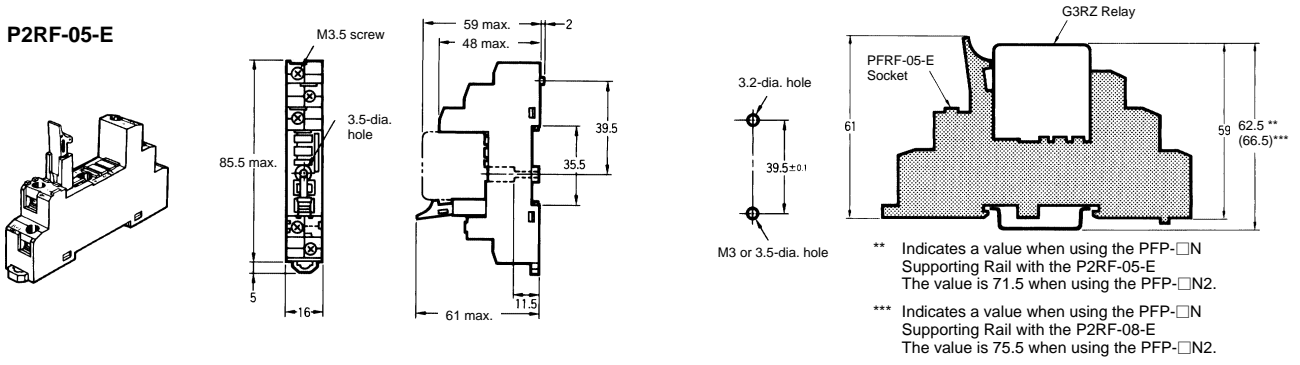

P2R-05A

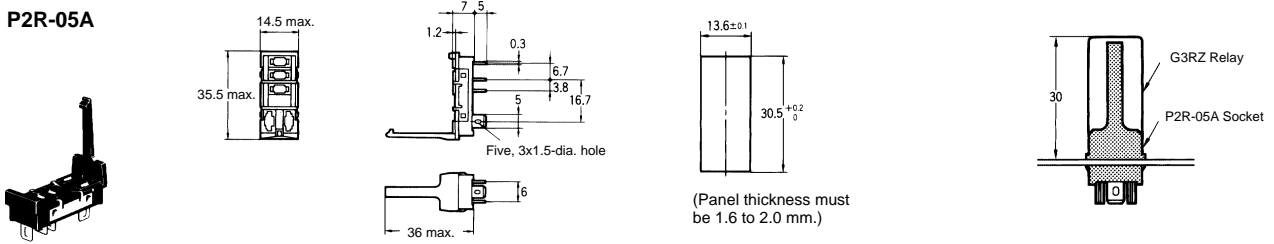

P2R-05P

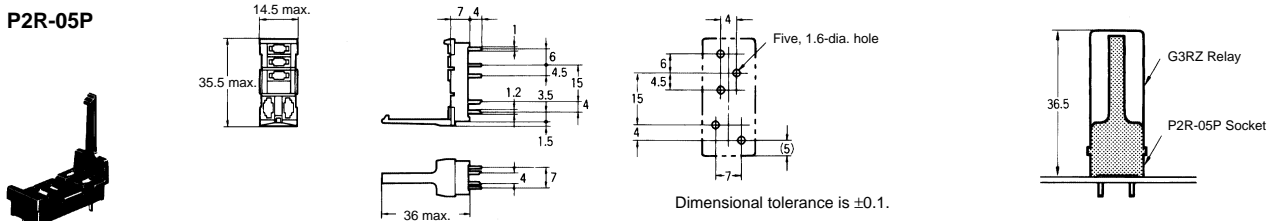

P2R-057P

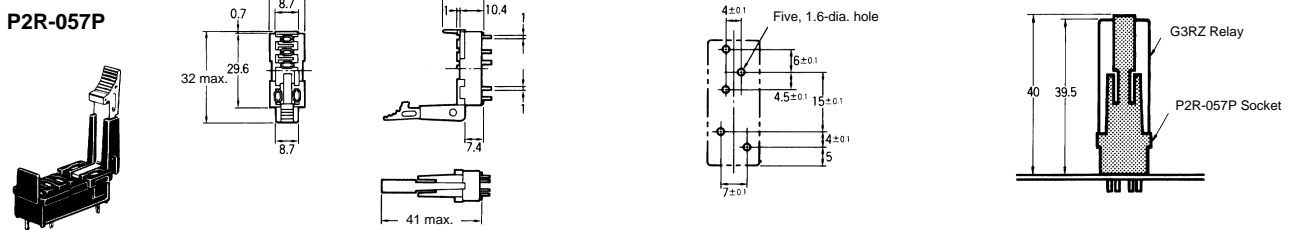

■ Connecting Socket Attaching Plate

Use the Socket Mounting Plate when arranging several Sockets in a row.

P2R-P

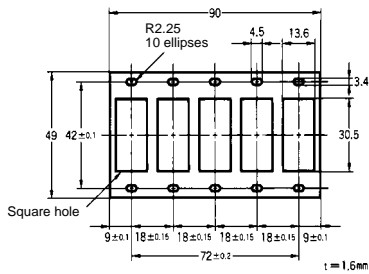

Precautions

Refer to pages 11 to 19 for general precautions.

Mounting

Ratings are measured at an ambient temperature of 40°C.

Socket Mounting



When mounting, take ventilation into consideration so that the heat of the MOS FET Relay is dissipated.

The temperature may rise.

Securely insert the MOS FET Relay to the socket.

ALL DIMENSIONS SHOWN ARE IN MILLIMETERS.

To convert millimeters into inches, multiply by 0.03937. To convert grams into ounces, multiply by 0.03527.