

## Solid-state Relay

## G3MC

### Compact, Thin-profile, Low-cost SSR Switching 1 A (PCB-mounting)

- Small bottom surface area (approx. 80% of the conventional G3MB's) and ideal for close PCB mounting.
- DC input and AC output for an applicable load of 1 A at 40°C.
- Compact, thin-profile SSR of monoblock construction with an all-in-one frame incorporates a PCB, terminals, and heat sink.
- Approved by UL and CSA.
- Conforms to VDE.

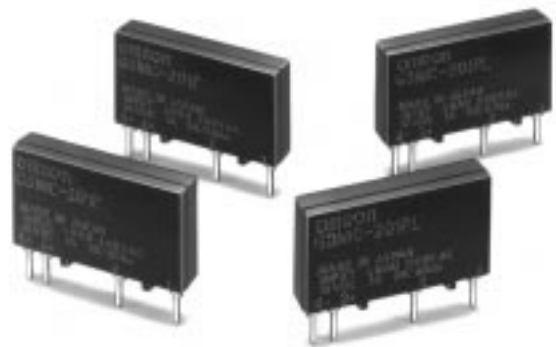

**Note:** Refer to *Precautions* on page 229.

### Ordering Information

Isolation	Zero-cross function	Indicator	Snubber circuit	Applicable output load	Rated input voltage	Model
Phototriac	Yes	No	Yes	1 A at 100 to 120 VAC	5 VDC	G3MC-101P(-VD)
					12 VDC	
					24 VDC	
	No			5 VDC	G3MC-101PL(-VD)	
						12 VDC
						24 VDC
	Yes	No	Yes	1 A at 100 to 240 VAC	5 VDC	G3MC-201P(-VD)
					12 VDC	
					24 VDC	
	No			5 VDC	G3MC-201PL(-VD)	
						12 VDC
						24 VDC
Yes	No	Yes	2 A at 100 to 240 VAC	5 VDC	G3MC-202P(-VD)	
				12 VDC		
				24 VDC		
No			5 VDC	G3MC-202PL(-VD)		
					12 VDC	
					24 VDC	

**Note:** When ordering models conforming to VDE(basic insulation), add "-VD" to the model number. Reinforced insulation models are also available. For details, contact your OMRON representative.

# Specifications

## ■ Ratings (Ambient Temperature 25°C)

### Input

Rated voltage	Operating voltage	Impedance	Voltage levels	
			Must operate voltage	Must dropout voltage
5 VDC	4 to 6 VDC	300 Ω ±20%	4 VDC max.	1 VDC min.
12 VDC	9.6 to 14.4 VDC	800 Ω ±20%	9.6 VDC max.	
24 VDC	19.2 to 28.8 VDC	1.6 kΩ ±20%	19.2 VDC max.	

**Note:** Each model has 5-VDC, 12-VDC, and 24-VDC input versions.

### Output

Model	Applicable load			
	Rated load voltage	Load voltage	Load current	Inrush current
G3MC-101P G3MC-101PL	100 to 120 VAC 50/60 Hz	75 to 132 VAC 50/60 Hz	0.1 to 1 A	8 A (60 Hz, 1 cycle)
G3MC-201P G3MC-201PL	100 to 240 VAC 50/60 Hz	75 to 264 VAC 50/60 Hz		
G3MC-202P(-VD) G3MC-202PL(-VD)	100 to 240 VAC 50/60 Hz	75 to 264 VAC 50/60 Hz	0.1 to 2 A	30 A (60 Hz, 1 cycle)

## ■ Characteristics

Item	G3MC-101P (-VD)	G3MC-101PL (-VD)	G3MC-201P (-VD)	G3MC-201PL (-VD)	G3MC-202P (-VD)	G3MC-202PL (-VD)
<b>Operate time</b>	1/2 of load power source cycle + 1 ms	1 ms max.	1/2 of load power source cycle + 1 ms	1 ms max.	1/2 of load power source cycle + 1 ms	1 ms max.
<b>Release time</b>	1/2 of load power source cycle + 1 ms)					
<b>Output ON voltage drop</b>	1.6 V (RMS) max.					
<b>Leakage current</b>	1 mA max. (at 100 VAC)		1.5 mA max. (at 200 VAC)			
<b>Insulation resistance</b>	1,000 MΩ min. (at 500 VDC)				---	
<b>Dielectric strength</b>	2,500 VAC, 50/60 Hz for 1 min					
<b>Vibration resistance</b>	Malfunction: 10 to 55 Hz, 0.75-mm double amplitude					
<b>Shock resistance</b>	Malfunction: 1,000 m/s <sup>2</sup>				---	
<b>Ambient temperature</b>	Operating: -30°C to 80°C (with no icing or condensation) Storage: -30°C to 100°C (with no icing or condensation)					
<b>Approved standards</b>	UL508 File No. E64562, CSA C22.2 (No. 14, No. 950) File No. LR35535, EN60950 File No. 5925UG ("VD" type)				---	
<b>Ambient humidity</b>	Operating: 45% to 85%					
<b>Weight</b>	Approx. 2.5 g				Approx. 5 g	

# Engineering Data

## Load Current vs. Ambient Temperature Characteristics

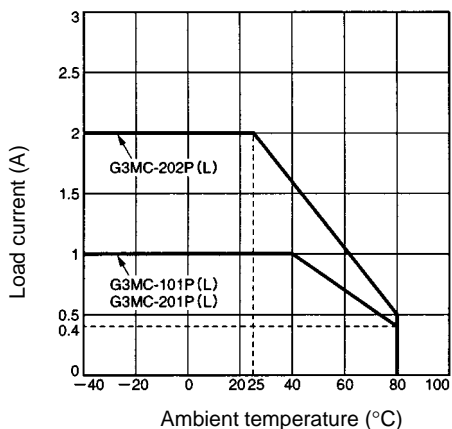

## Inrush Current Resistivity

Non-repetitive (Keep the inrush current to half the read value if it occurs repeatedly.)

### G3MC-202P(L)

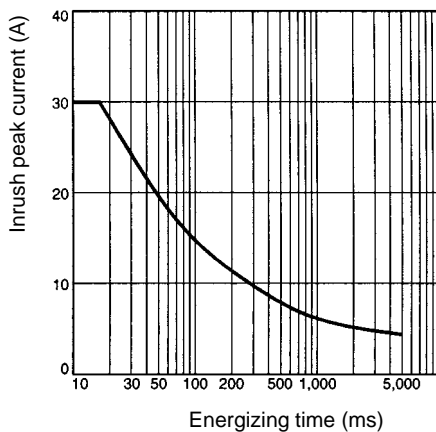

## Inrush Current Resistivity

Non-repetitive (Keep the inrush current to half the read value if it occurs repeatedly.)

### G3MC-101P(L), G3MC-201P(L)

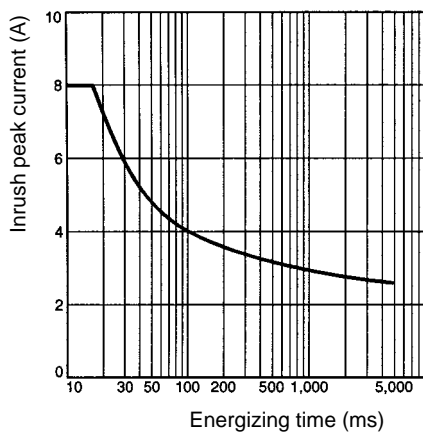

# Dimensions

**Note:** All units are in millimeters unless otherwise indicated.

## G3MC-101P(L)(-VD), G3MC-201P(L)(-VD)

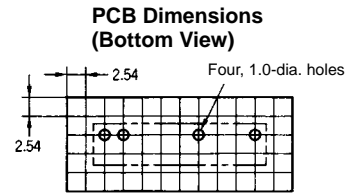
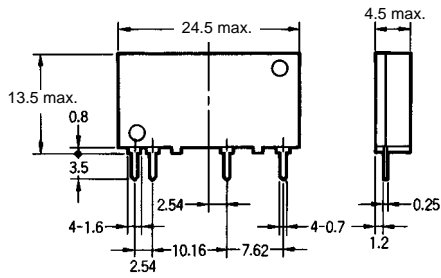
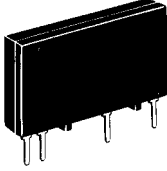

### Terminal Arrangement (Bottom View)

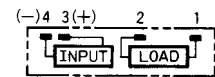

## G3MC-202P(L)(-VD)

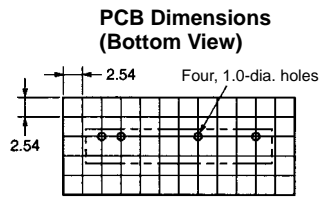
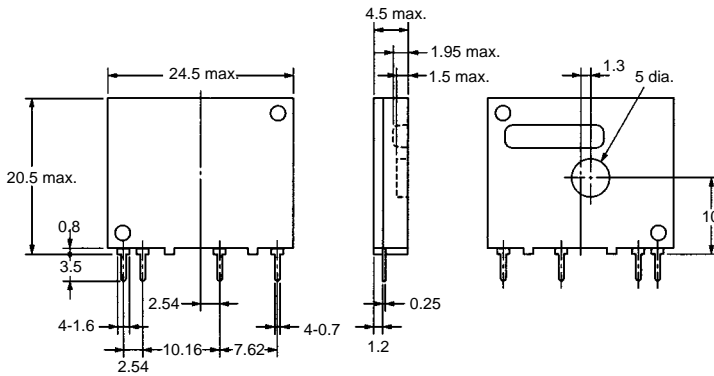

### Terminal Arrangement (Bottom View)

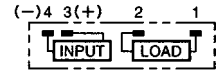

# Precautions

## General Precautions

Be sure to turn off power to the SSR before wiring the SSR, otherwise an electric shock may be received.

Do not touch the terminals of the SSR while power is being supplied to the SSR. The terminals are charged with the power, and an electric shock may be received by touching the terminals.

The built-in capacitor may have a residual voltage after the SSR is turned off. Be sure to discharge the residual voltage before touching the terminals of the SSR, otherwise an electric shock may be received.

## Mounting

1. Make sure that no excessive voltage or current is imposed on or flows to the input or output circuit of the SSR, otherwise the SSR may malfunction or burn.
2. Solder the terminals of the SSR properly under the required soldering conditions. The SSR may be abnormally heated and burn if power is supplied to the terminals soldered incorrectly.
3. Do not short-circuit the load of the SSR while power is supplied to the SSR. Do not short-circuit the power supply through the SSR. The SSR may be damaged, malfunction, or burn if the load or power supply is short-circuited.

## Correct Use

The terminals of the SSR are highly heat-conductive. Each terminal must be soldered within 10 s at 260°C or within 5 s at 350°C.

The SSR is of a thin-profile construction. To maintain the vibration resistance of the SSR, make sure that the space between the SSR and PCB is 0.1 mm maximum. Lifting of the PCB can be prevented by setting the hole diameter of the PCBs on both sides slightly smaller than the actual terminal dimension.

Select the model without the zero-cross function when using the Unit for phase control output.

The casing works as a heat sink. When mounting two or more Units closely, make sure that the Units are properly ventilated by taking ambient temperature rises into consideration. If Units are closely mounted and used in places with no ventilation, the load current of each Unit must be 1/2 of the rated load current.

## Fusing characteristics

The G3MC has a function that forces an open mode failure when an overcurrent exceeds the rated value. The fusing characteristics of the G3MC, however, are not the same as those of a general-use glass fuse. Machines that use the G3MC must be provided with a safety device, such as a fuse or breaker, and ON-OFF tests or short-circuit tests must be implemented to confirm the following items and detailed influences. Users must determine test conditions and implement tests on reliability as required by the machine.

1. Life test under continuous electric current
2. On-off cycle test
3. Influence by ambient temperature
4. Influence by power source frequency
5. Influence by power source voltage fluctuation

**Note:** Contact your local OMRON sales office for more detailed information.

## Protective Element

No overvoltage absorption element is built in. Therefore, if the G3MC is connected to an inductive load, be sure to connect the overvoltage absorption element.

### G3MC-□□□PL (without Zero cross function)

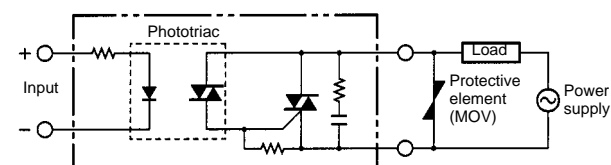

### G3MC-□□□P (with Zero cross function)

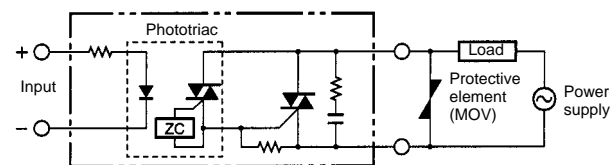

**ALL DIMENSIONS SHOWN ARE IN MILLIMETERS.**

To convert millimeters into inches, multiply by 0.03937. To convert grams into ounces, multiply by 0.03527.