

Solid-state Relay

G3CN

PCB-mounting SSR for FA Equipment Requiring High Reliability

- Wide I/O voltage range: 3 to 28 VDC input and 75 to 264 VAC output or 3 to 28 VDC input and 3 to 52.8 VDC output.
- Two load currents available: 2 A and 3 A
- Flat and vertical models available for a variety of applications.
- Approved by UL and CSA.

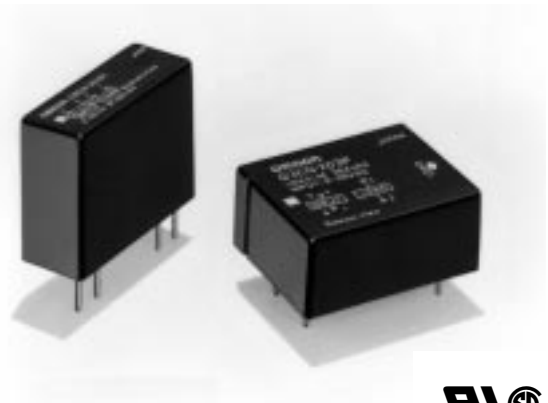

Ordering Information

Isolation	Zero cross function	Indicator	Rated output voltage (Applicable output load)	Rated input voltage	Model
Photocoupler	Yes	No	2 A at 100 to 240 VAC (2 A at 75 to 264 VAC)	4 to 24 VDC	G3CN-202P-US
					G3CN-202P1-US*
			3 A at 100 to 240 VAC (3 A at 75 to 264 VAC)		G3CN-203P-US
					G3CN-203P1-US*
Phototriac	No		2 A at 100 to 240 VAC (2 A at 75 to 264 VAC)	5, 12, 24 VDC**	G3CN-202PL-US
					G3CN-202PL1-US*
			3 A at 100 to 240 VAC (3 A at 75 to 264 VAC)		G3CN-203PL-US
					G3CN-203PL1-US*
Photocoupler	---		2 A at 4 to 48 VDC (2 A at 3 to 52.8 VDC)	4 to 24 VDC	G3CN-DX02P-US
					G3CN-DX02P1-US*
			3 A at 4 to 48 VDC (3 A at 3 to 52.8 VDC)		G3CN-DX03P-US
					G3CN-DX03P1-US*

*Vertical models.

**When ordering, specify the input voltage

Specifications

■ Ratings

Input

Model	Rated voltage	Operating voltage	Impedance	Voltage level	
				Must operate voltage	Must release voltage
G3CN-202P(1)-US G3CN-203P(1)-US	4 to 24 VDC	3 to 28 VDC	1.5 k Ω $^{+20\%}_{-10\%}$	3 VDC max.	1 VDC min.
G3CN-202PL(1)-US G3CN-203PL(1)-US	5 VDC	4 to 6 VDC	390 Ω $\pm 20\%$	4 VDC max.	
	12 VDC	9.6 to 14.4 VDC	900 Ω $\pm 20\%$	9.6 VDC max.	
	24 VDC	19.2 to 28.8 VDC	2 k Ω $\pm 20\%$	19.2 VDC max.	
G3CN-DX02P(1)-US G3CN-DX03P(1)-US	4 to 24 VDC	3 to 28 VDC	1.5 k Ω $^{+20\%}_{-10\%}$	3 VDC max.	

Note: The input impedance is measured at the maximum value of the operating voltage. For example, with the model rated at 4 to 24 VDC, the input impedance is measured at 28 VDC.

Output

Model	Applicable load			
	Rated load voltage	Load voltage range	Load current	Inrush current
			Without heat sink	
G3CN-202P(1)-US G3CN-202PL(1)-US	100 to 240 VAC	75 to 264 VAC	0.1 to 2 A	30 A (60 Hz, 1 cycle)
			0.1 to 3 A	45 A (60 Hz, 1 cycle)
G3CN-203P(1)-US G3CN-203PL(1)-US	4 to 48 VDC	3 to 52.8 VDC	0.1 to 2 A	12 A (10 ms)
			0.1 to 3 A	18 A (10 ms)

■ Characteristics

Item	G3CN-202P(1)/203P(1)-US	G3CN-202PL(1)/203PL(1)-US	G3CN-DX02P(1)/03P(1)-US
Operate time	1/2 of load power source cycle + 1 ms max.	1 ms max.	0.5 ms max.
Release time	1/2 of load power source cycle + 1 ms max.	1/2 of load power source cycle + 1 ms max.	2 ms max.
Output ON voltage drop	1.6 V (RMS) max.		1.5 V max.
Leakage current	5 mA max. (at 100 VAC) 10 mA max. (at 200 VAC)	2.5 mA max. (at 100 VAC) 5 mA max. (at 200 VAC)	5 mA max. (at 50 VDC)
Insulation resistance	100 M Ω min. (at 500 VDC)		
Dielectric strength	2,500 VAC, 50/60 Hz for 1 min		
Vibration resistance	Malfunction: 10 to 55 Hz, 1.5-mm double amplitude		
Shock resistance	Malfunction: 1,000 m/s ²		
Ambient temperature	Operating: -30°C to 80°C (with no icing nor condensation) Storage: -30°C to 100°C (with no icing nor condensation)		
Ambient humidity	Operating: 45% to 85%		
Approved standards	UL508, UL114 File No.E64562, CSA C22.2 (No.0, No.14) File No. LR35535		
Weight	Approx. 25 g		

Engineering Data

Load Current vs. Ambient Temperature Characteristics

G3CN-202P(1)/-202PL(1)/-DX02P(1)-US

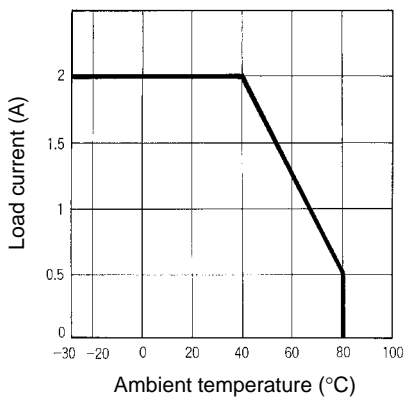

G3CN-203P(1)/-203PL(1)/-DX03P(1)-US

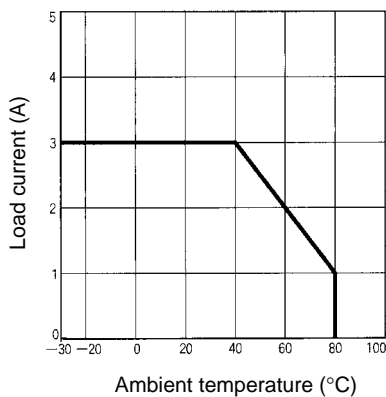

Inrush Current Resistivity

Non-repetitive (Keep the inrush current to half the rated value if it occurs repetitively.)

G3CN-202P(1)/-202PL(1)-US

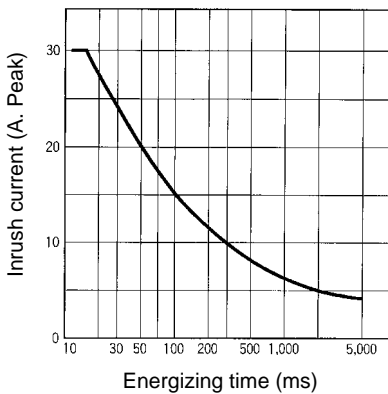

G3CN-DX02P(1)-US

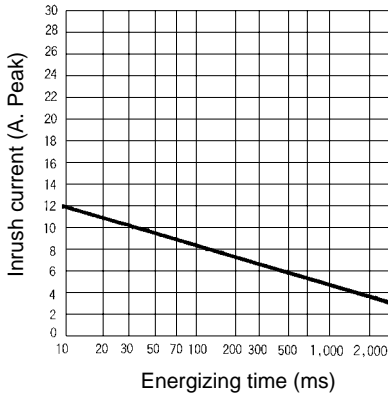

G3CN-203P(1)/-203PL(1)-US

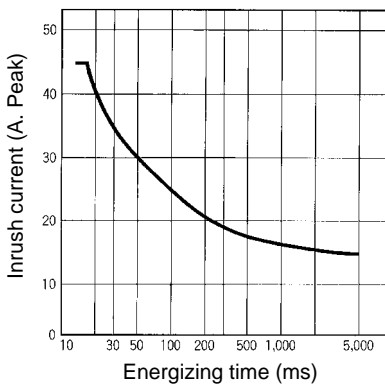

G3CN-DX03P(1)-US

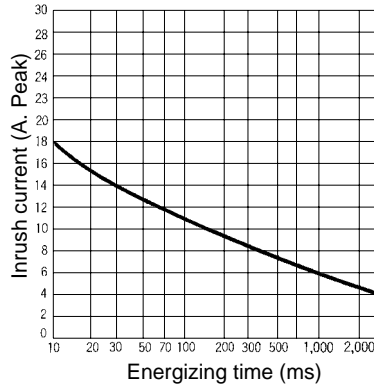

Dimensions

Note: All units are in millimeters unless otherwise indicated.

Flat Model

G3CN-20□P/-20□PL/-DX0□P

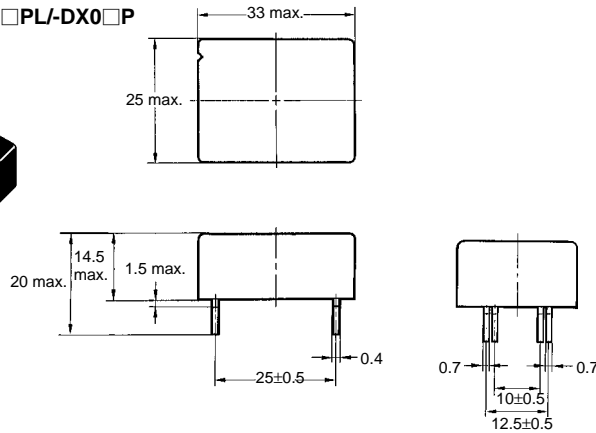
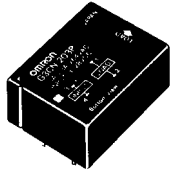

Terminal Arrangement/ Mounting Holes (Bottom View)

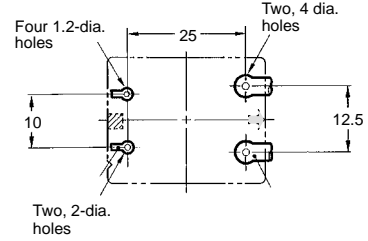

Terminal Arrangement/ Internal Connections (Bottom View)

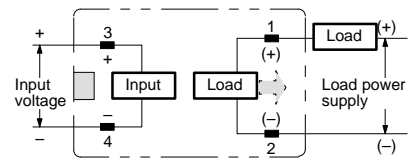

Note: Values in parentheses apply to the DC-load versions.

Vertical Model

G3CN-20□P1/-20□PL1/-DX0□P1

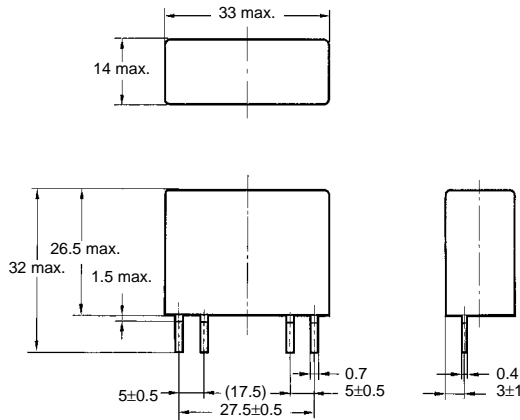
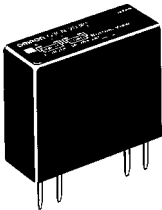

Terminal Arrangement/ Mounting Holes (Bottom View)

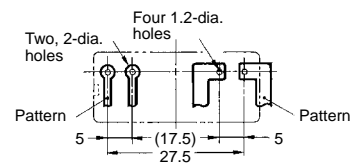

Terminal Arrangement/ Internal Connections (Bottom View)

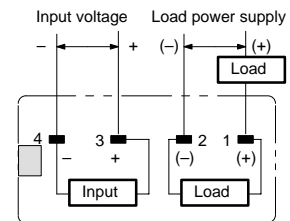

Note: Values in parentheses apply to the DC-load versions.

Precautions

Refer to pages 11 to 19 for general precautions.

Connection

With the SSR for DC switching, the load can be connected to either positive or negative output terminal of the SSR.

Protective Component

Since the SSR does not incorporate an overvoltage absorption component, be sure to connect an overvoltage absorption component when using the SSR under an inductive load.

ALL DIMENSIONS SHOWN ARE IN MILLIMETERS.

To convert millimeters into inches, multiply by 0.03937. To convert grams into ounces, multiply by 0.03527.