

- Third generation surface mount design
- Design is based on worldwide telecommunications, data communications, computer peripheral and office automation relay requirements
- High dielectric withstand voltage of 2,000 VAC between coil and contacts (standard type)
- Meets 2.5kV Bellcore surge requirement
- Offers significant board space savings
- European version certified for EN60950/EN41003 Supplementary Insulation at 250 V
- Available in PCB through-hole terminal configuration
- Tape and reel packaging option available

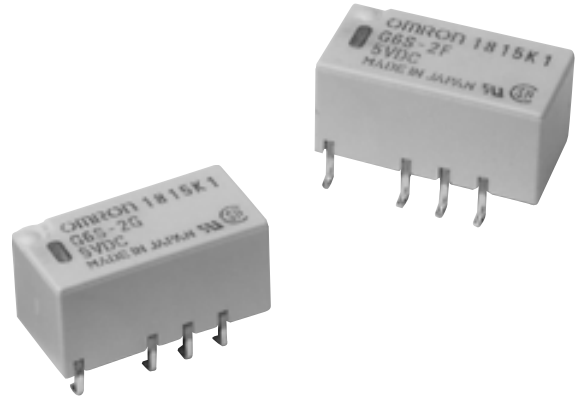

Ordering Information

To Order: Select the part number and add the desired coil voltage rating, (e.g., G6S-2F-DC12).

STANDARD VERSION

Terminal	Contact form	Part number			
		Non-latching	Single coil latching	Dual coil latching	High-sensitivity dual coil latching
Gull-wing	DPDT	G6S-2F	G6SU-2F	G6SK-2F	G6SK-2F-H
Inside "L"	DPDT	G6S-2G	G6SU-2G	G6SK-2G	G6SK-2G-H
PCB through-hole	DPDT	G6S-2	G6SU-2	G6SK-2	G6SK-2-H

EUROPEAN VERSION

Certified for EN60950/EN41003 Supplementary Insulation at 250 V

Terminal	Contact form	Part number
		Non-latching
Gull-wing	DPDT	G6S-2F-Y
Inside "L"	DPDT	G6S-2G-Y
PCB through-hole	DPDT	G6S-2-Y

Specifications

■ CONTACT DATA

Load	Resistive load (cos ϕ = 1)
Rated load	0.5 A at 125 VAC 2 A at 30 VAC
Contact material	Ag (Au clad)
Max. carry current	2 A
Max. operating voltage	250 VAC, 220 VDC
Max. operating current	2 A
Max. switching capacity	62.5 VA, 60 W
Min. permissible load	10 mVDC, 10 μ A

■ COIL DATA

G6S – Standard non-latching (G6S-2F, G6S-2G, G6S-2)

Rated voltage (VDC)	Rated current (mA)	Coil resistance (Ω)	Pick-up voltage	Dropout voltage	Maximum voltage	Power consumption (mW)
			% of rated voltage			
3	46.7	64.3	75% max.	10% min.	200% max.	140
4.5	31.0	145				
5	28.1	178				
6	23.3	257				
9	15.5	579				
12	11.7	1,028				
24	8.3	2,880	75% max.	10% min.	170% max.	200

G6SU – Standard single coil latching (G6SU-2F, G6SU-2G, G6SU-2)

Rated voltage (VDC)	Rated current (mA)	Coil resistance (Ω)	Set pick-up voltage	Reset pick-up voltage	Maximum voltage	Power consumption (mW)
			% of rated voltage			
3	33.3	90	75% max.	75% max.	180% max.	100
4.5	22.2	203				
5	20.0	250				
6	16.7	360				
9	11.1	810				
12	8.3	1,440				
24	6.3	3,840	75% max.	75% max.	180% max.	150

G6SK – Standard dual coil latching (G6SK-2F, G6SK-2G, G6SK-2)

Set coil			Reset coil		Set pick-up voltage	Reset pick-up voltage	Maximum voltage	Power consumption (mW)
Rated voltage (VDC)	Rated current (mA)	Coil resistance (Ω)	Rated current (mA)	Coil resistance (Ω)				
3	66.6	45	66.6	45	75% max.	75% max.	170% max.	200
4.5	44.4	101	44.4	101				
5	40.0	125	40.0	125				
6	33.3	180	33.3	180				
9	22.2	405	22.2	405				
12	16.7	720	16.7	720				
24	12.5	1,920	12.5	1,920	75% max.	75% max.	140% max.	300

■ COIL DATA (continued)

G6SK – Standard high-sensitivity dual coil latching (G6SK-2F-H, G6SK-2G-H, G6SK-2-H)

Set coil			Reset coil		Set pick-up voltage % of rated voltage	Reset pick-up voltage	Maximum voltage	Power consumption (mW)
Rated voltage (VDC)	Rated current (mA)	Coil resistance (Ω)	Rated current (mA)	Coil resistance (Ω)				
3	46.7	64.3	46.7	64.3	75% max.	75% max.	130% max.	140
4.5	31.0	145	31.0	145				
5	28.1	178	28.1	178				
6	23.3	257	23.3	257				
9	15.6	579	15.6	579				
12	11.7	1,028	11.7	1,028	75% max.	75% max.	130% max.	200
24	8.33	2,880	8.33	2,880				

G6S – European version, non-latching (G6S-2F-Y, G6S-2G-Y, G6S-2-Y)

Rated voltage (DC)	Rated current (mA)	Coil resistance (Ω)	Pick-up voltage	Dropout voltage	Maximum voltage	Power consumption (mW)
			% of rated voltage			
3	66.7	45	75% max.	10% min.	130% max.	200
4.5	44.6	101				
5	40.0	125				
6	33.3	180				
9	22.2	405				
12	16.7	720	75% max.	10% min.	110% max.	230
24	9.58	2,504				

- Note: 1. The rated current and coil resistance are measured at a coil temperature of 23°C (73°F) with a tolerance of $\pm 10\%$.
 2. The operating characteristics are measured at a coil temperature of 23°C (73°F) unless otherwise specified.
 3. Pick-up voltage is measured with no carry current across the contacts.
 4. Pick-up voltage will vary with temperature.

■ CHARACTERISTICS

Contact resistance	75 m Ω max.	
Operate (set) time	4 ms max. (mean value approx. 2.5 ms G6S; 2.0 ms G6SU, G6SK)	
Release (reset) time	4 ms max. (mean value approx. 1.5 ms G6S; 2.0 ms G6SU, G6SK)	
Bounce time	Approx. 0.5 ms	
Insulation resistance	1,000 M Ω min. (at 500 VDC)	
Dielectric strength	2,000 VAC, 50/60 Hz for 1 minute (G6S, G6SU) between coil and contacts 1,000 VAC, 50/60 Hz for 1 minute (G6SK) between coil and contacts 1,500 VAC, 50/60 Hz for 1 minute between contacts of different poles 1,000 VAC, 50/60 Hz for 1 minute between contacts of same pole	
Surge withstand voltage	2,500 V, 2 x 10 μ S (conforms to Bellcore specifications) for G6S and G6SU; 1,500 V, 10 x 160 μ S (conforms to FCC part 68) for G6SK between coil and contacts 2,500 V, 2 x 10 μ S (conforms to Bellcore specs.) between contacts of different poles 1,500 V, 10 x 160 μ S (conforms to FCC part 68) between contacts of same pole	
Vibration	Mechanical durability	10 to 55 Hz; 5 mm (0.20 in) double amplitude
	Malfunction durability	10 to 55 Hz; 3.3 mm (0.13 in) double amplitude
Shock	Mechanical durability	1,000 m/s ² ; approx. 100 G
	Malfunction durability	750 m/s ² ; approx. 75 G
Ambient temperature	-40 to +85°C (-40°F + 185°F)	
Humidity	35 to 85% RH	
Service life	Mechanical	100,000,000 operations min. (at 36,000 operations/hour)
	Electrical	See "Characteristic Data"
Weight	Approx. 2g (0.07 oz)	

Note: Data shown are of initial value.

CHARACTERISTIC DATA

Maximum switching capacity

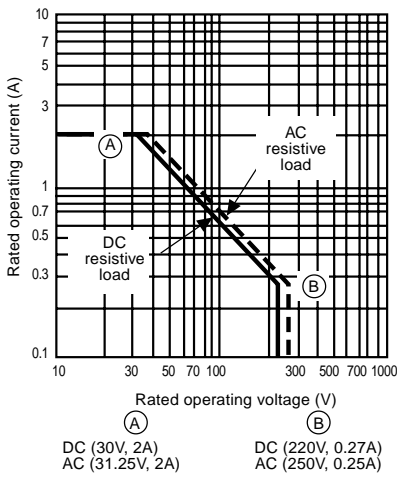

Ambient temperature vs. maximum coil voltage (G6S)

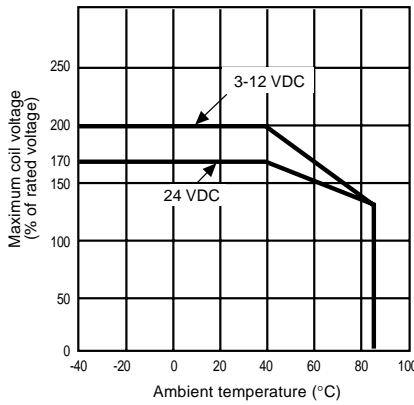

Ambient temperature vs. maximum coil voltage (G6SU, G6SK)

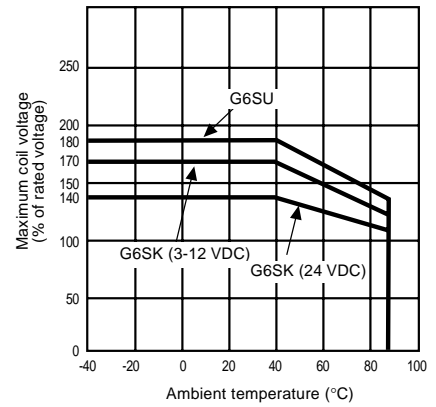

Service Life

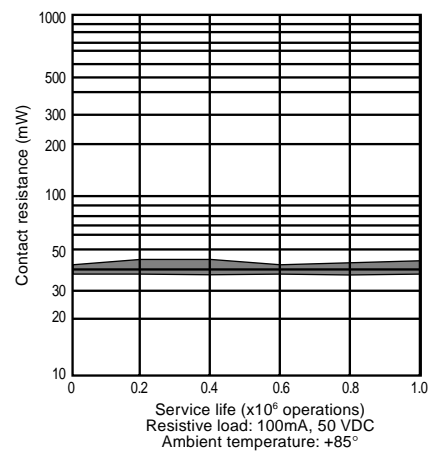
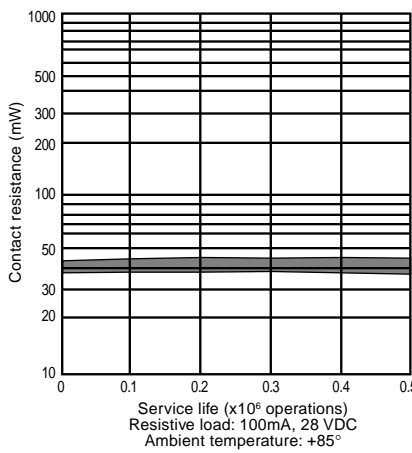
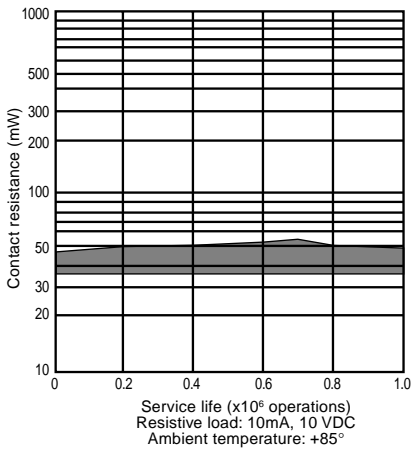

Electrical service life

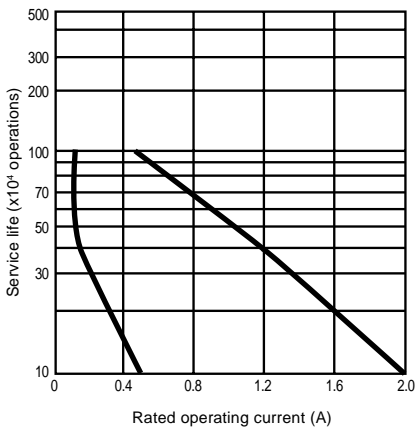

Dielectric strength (Standard version, non-latching)
Detecting current: 1mA

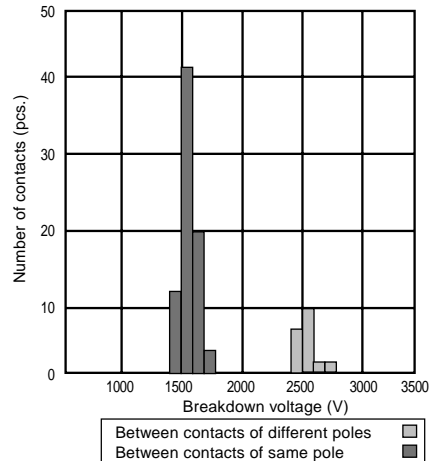
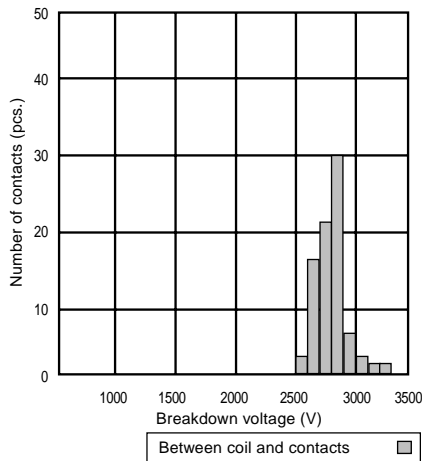

Impulse withstand voltage (Standard version, non-latching)

(2 x 10 μs)

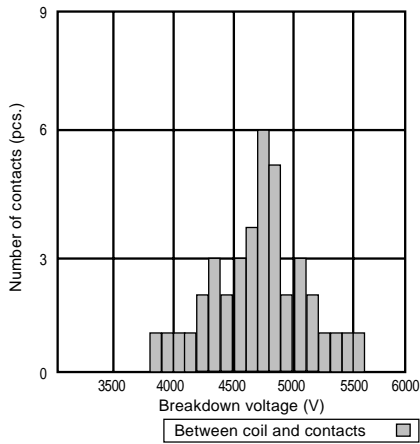

(10 x 160 μs)

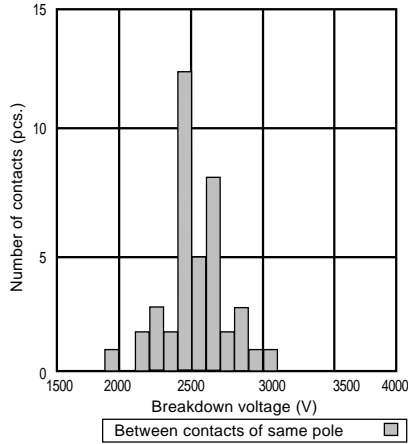

(10 x 160 μs)

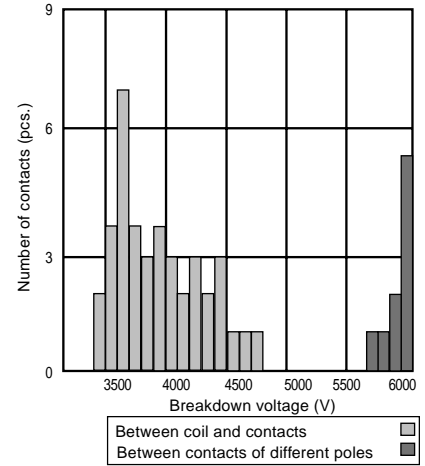

Impulse withstand voltage (European version)

(10 x 160 μs)

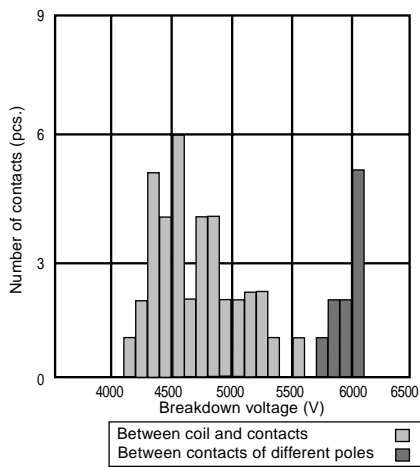

(10 x 160 μs)

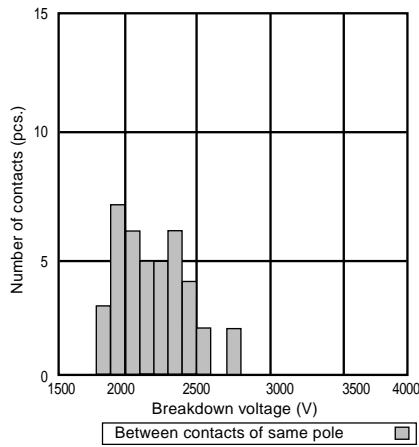

(2 x 10 μs)

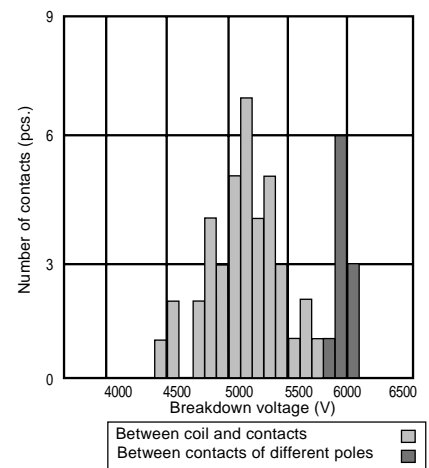

Dielectric strength (European version, non-latching)

Detecting current: 1mA

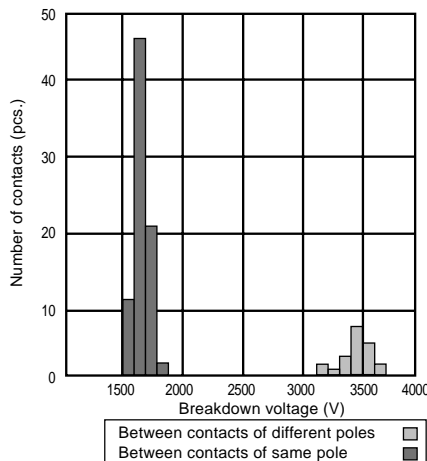
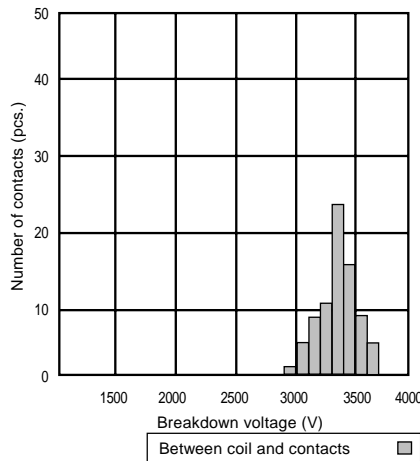

Dimensions

Unit: mm (inch)

STANDARD

G6S-2F,
G6S-2F-Y

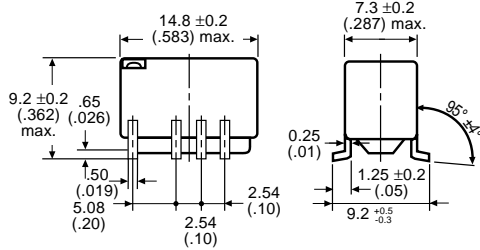
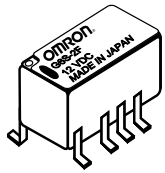

Terminal arrangement/
Internal connections
(Top view)

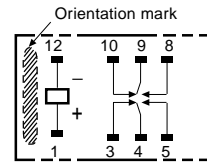

Mounting pads
(Top view)

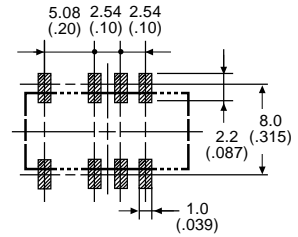

G6S-2G,
G6S-2G-Y

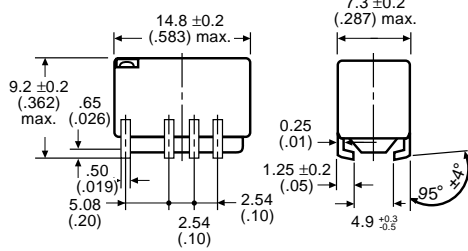
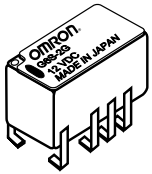

Terminal arrangement/
Internal connections
(Top view)

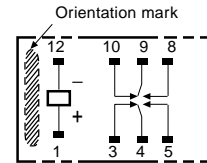

Mounting pads
(Top view)

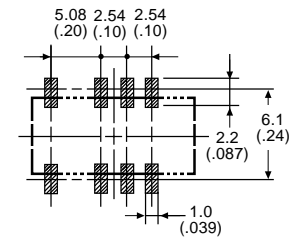

G6S-2,
G6S-2-Y

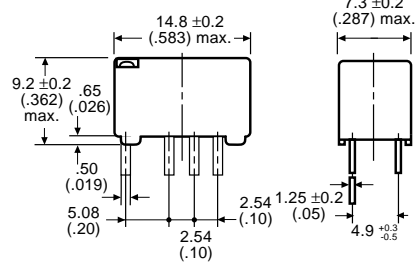
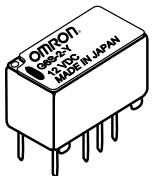

Terminal arrangement/
Internal connections
(Bottom view)

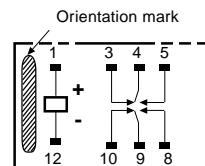

Mounting holes
(Bottom view)

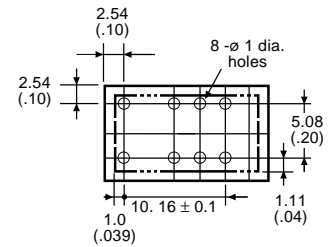

■ SINGLE COIL LATCHING

G6SU-2F

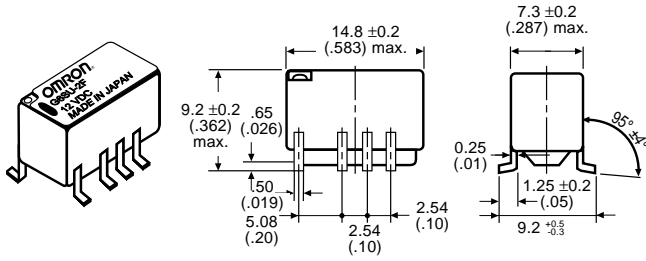

Terminal arrangement/
Internal connections
(Top view)

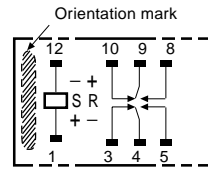

Mounting pads
(Top view)

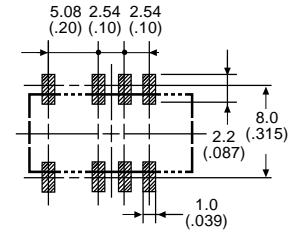

G6SU-2G

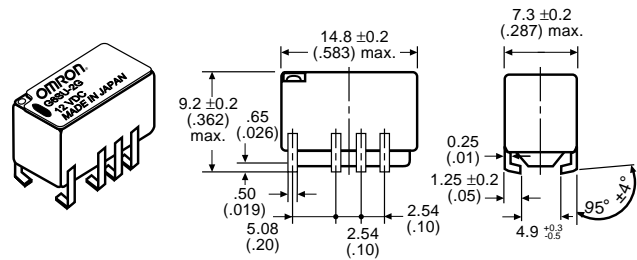

Terminal arrangement/
Internal connections
(Top view)

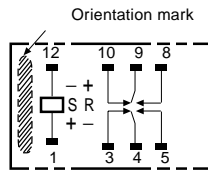

Mounting pads
(Top view)

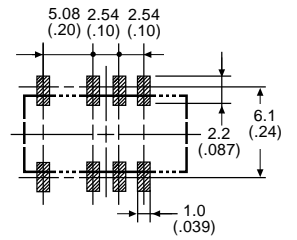

G6SU-2

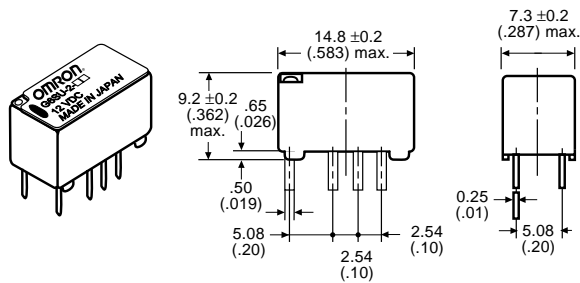

Terminal arrangement/
Internal connections
(Bottom view)

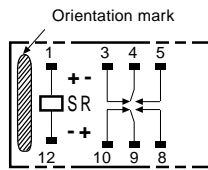

Mounting holes
(Bottom view)

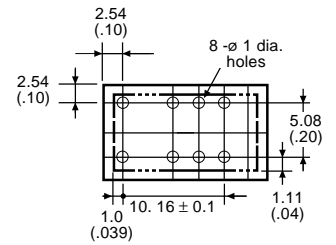

Unit: mm (inch)

■ DUAL COIL LATCHING

G6SK-2F,
G6SK-2F-H

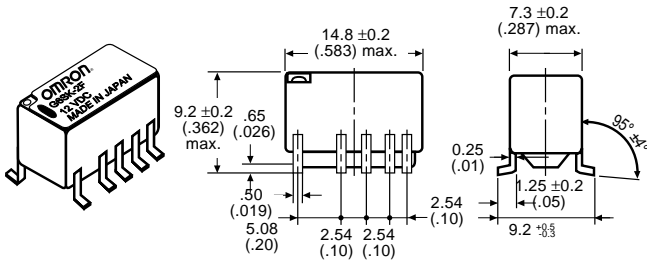

Terminal arrangement/
Internal connections
(Top view)

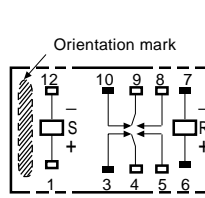

Mounting pads
(Top view)

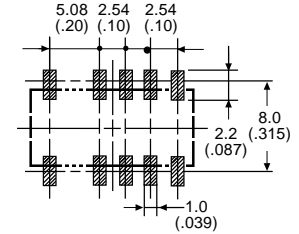

G6SK-2G,
G6SK-2G-H

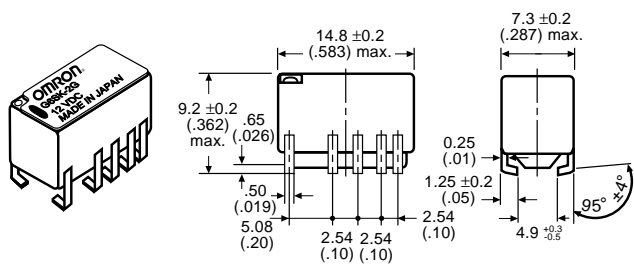

Terminal arrangement/
Internal connections
(Top view)

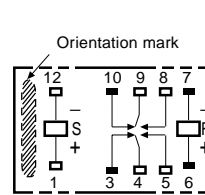

Mounting pads
(Top view)

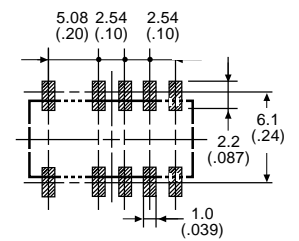

G6SK-2,
G6SK-2-H

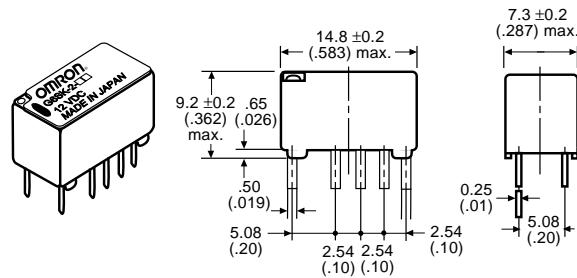

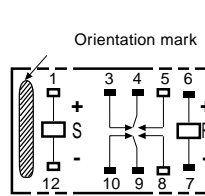

Terminal arrangement/
Internal connections
(Bottom view)

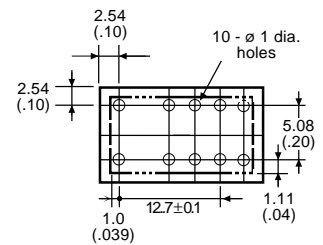

Mounting holes
(Bottom view)



- Note: 1. Coplanarity is 0.1 mm max.
2.  and  indicate mounting orientation marks.

■ ACCESSORIES

Tube packing	Standard nomenclature	50 pcs per anti-static tube
Tape packing	When ordering, add "TR" before the rated coil voltage (e.i., G6S-2F-TR-DC12) Note: TR is not part of the relay model number and will not be marked on the relay	

■ DIMENSIONS

Relays per reel: 400

Reels per packing carton: 2 (800 relays)

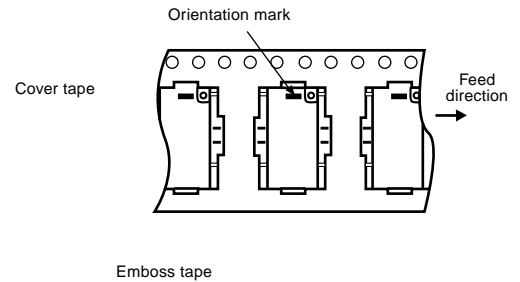
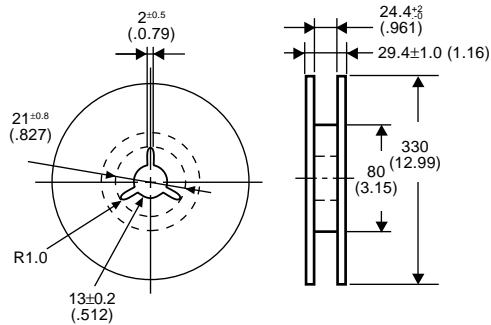

■ APPROVALS

UL (File No. E41515)/ CSA (File No. LR24825)

Type	Contact Form	Coil Rating	Contact Ratings
G6S-2F	DPDT	1.5 to 48 VDC	0.5 A, 125 VAC
G6S-2F-Y			0.3 A, 110 VDC
G6S-2G			2.0 A, 30 VDC
G6S-2G-Y			
G6S-2			
G6S-2-Y			
G6SU-2F			
G6SU-2G			
G6SU-2			
G6SK-2F			
G6SK-2G			
G6SK-2			
G6SK-2F-H			
G6SK-2G-H			
G6SK-2-H			

Note: 1. The rated values approved by each of the safety standards (e.g., UL and CSA) may be different from the performance characteristics individually defined in this catalog.

Omron Europe B.V. EMA-ISD, tel:+31 23 5681390, fax:+31 23 5681397, <http://www.eu.omron.com/ema>