

Electromagnetic Counter CSKE

Compact and Economical Totalizing Counter

- Four mounting methods
- Three supply voltages for AC models and five for DC models
- DC models can be driven by a single-phase, full-wave rectified power source
- Six-digit and seven-digit models available



Ordering Information

Mounting method*	Surface mounting I	Flush mounting I	Surface mounting II	Flush mounting II	
Operating mode	Up counting				
External connection	BY lead wires				
Count input	Contact (voltage) input				
Digit drive system	Half-digit drive system				
Number of digits and model	6	CSKE-6R	CSKE-6F	CSKE-6RL	CSKE-6Y
	7	CSKE-7R	CSKE-7F	CSKE-7RL	CSKE-7Y

- Note:** 1. When placing your order, specify the desired supply voltage listed in *Specifications* and a UL listed model if required, in addition to the model number.
 2. If a UL listed model is required, specify this in your order in addition to the desired model number.

* Mounting Method

Surface mounting I (-R models)	Flush mounting I (-F models)	Surface mounting II (-RL models)	Flush mounting II (-Y models)

Specifications

■ Ratings

Supply voltage (see note)	24, 48, 100 VAC, 50/60 Hz 6, 12, 24, 48, 100 VDC (Can be used with a single-phase, full-wave rectified power source. Contains 48% ripple max.)
Operating voltage range	85 to 110% of rated supply voltage
Power consumption	AC: approx. 2 VA DC: approx. 2 W
Maximum counting speed	10 cps (contact input) Minimum signal width: 50 ms min. (Duty factor: 1:1)
Character height	4 mm

Note: The DC models have no polarity.

■ Characteristics

Insulation resistance	100 M Ω min. (at 500 VDC)
Dielectric strength	1,500 VAC, 50/60 Hz for 1 minute
Vibration resistance	Destruction: 10 to 25 Hz, 2 mm double amplitude Malfunction: 10 to 55 Hz, 0.5 mm double amplitude
Shock resistance	Destruction: 300 m/s ² (approx. 30 G) Malfunction: 50 m/s ² (approx. 5 G)
Ambient temperature	Operating: -10°C to 40°C
Ambient humidity	45% to 85%
Life expectancy	10,000,000 counts
Approved standards (see note)	UL508, CSA C22.2 No.14
Weight	Approx. 100 g

Note: These standards apply to the -US models only.

Dimensions

CSKE-6R CSKE-7R

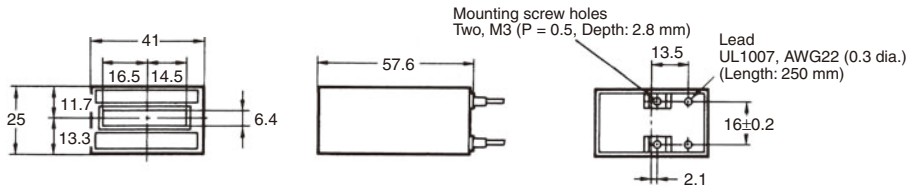

CSKE-6F CSKE-7F

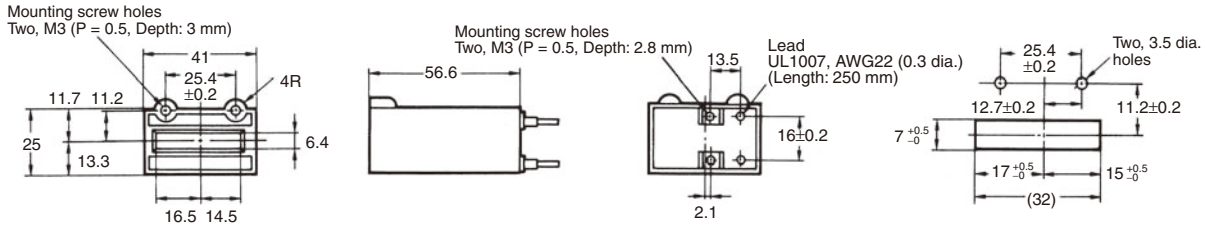

CSKE-6RL CSKE-7RL

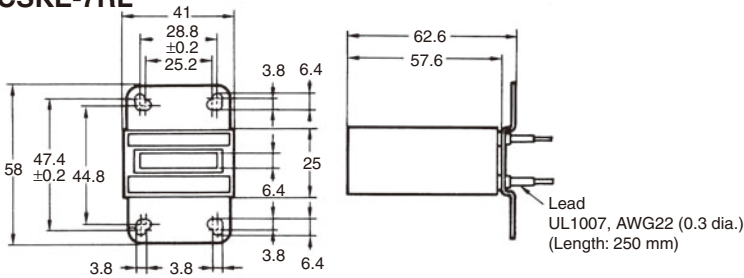

CSKE-6Y CSKE-7Y

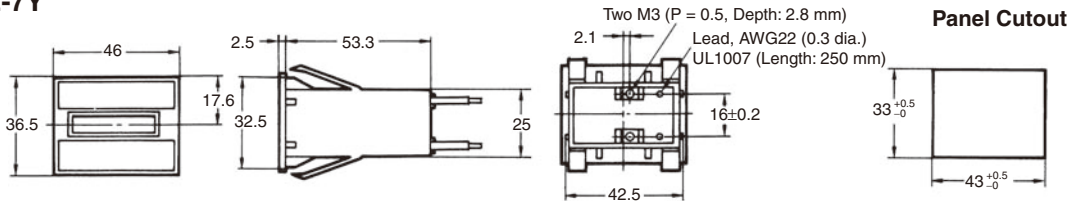

Safety Precautions

Mounting/Connection

Whenever possible, install the Counter at an environment where it is not subject to heavy vibration, dust, and corrosive gases. When mounting the Counter on a panel with screws, do not apply excessive force on the screws when tightening, but be sure to tighten the screws securely. To flush-mount the Counter (a -Y model), insert it into the cutout on the mounting panel, until its class catch securely.

Use lead wires approximately 250 mm long. Do not stretch the leads with excessive force. Insulate the leads with insulation tape, etc.

When mounting the Counter using its screw holes, use screws that fit the holes properly. Also when determining the length of the screws, take the thickness of the mounting panel into consideration.

Supply Voltage

The Counter operates on a voltage 85% to 110% of the rated supply voltage. If the supply voltage exceeds or drops below this range, the Counter may malfunction. The DC models can operate with a ripple factor of 48% or less; so, they can be driven by a single-phase, full-wave rectified power source, whose waveform is shown below.

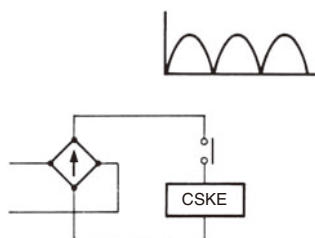

Count Signal

(1) Contact Input

When using a contact input device to input the count signal, carefully select the input device. Use the current capacity and life of the contact of the input device as criteria for the selection. It is recommended to connect a protective circuit across the contacts of the input device, or a surge absorber across the Counter's coil, so that surges are absorbed and the life of the contacts are extended.

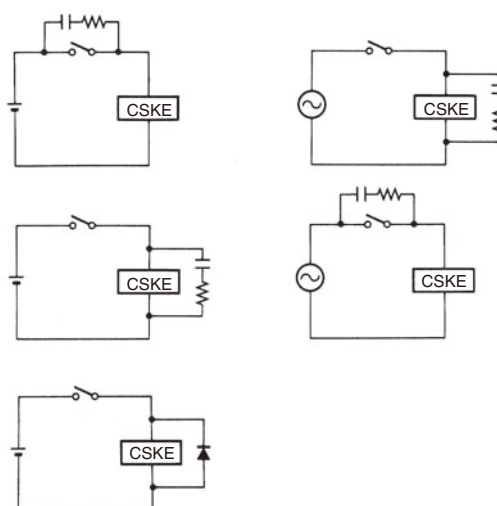

(2) Solid-state Input

When a solid-state input device is used, a surge absorber is necessary to protect the Counter drive transistor from being adversely affected by noises. If a diode is used as the surge absorber, the reset time of the Counter will be prolonged and, as a result, the Counter's response speed will be slowed down. If an RC network is used, the response characteristics of the Counter will be better as compared when a diode is used, but the counterelectromotive force cannot be completely reduced to zero.

Diode

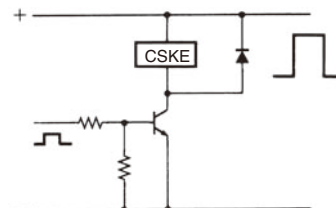

RC network

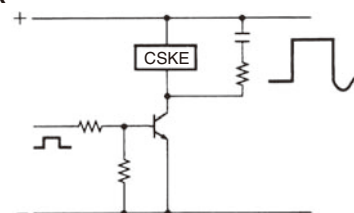

ALL DIMENSIONS SHOWN ARE IN MILLIMETERS.

To convert millimeters into inches, multiply by 0.03937. To convert grams into ounces, multiply by 0.03527.

In the interest of product improvement, specifications are subject to change without notice.

Read and Understand This Catalog

Please read and understand this catalog before purchasing the products. Please consult your OMRON representative if you have any questions or comments.

Warranty and Limitations of Liability

WARRANTY

OMRON's exclusive warranty is that the products are free from defects in materials and workmanship for a period of one year (or other period if specified) from date of sale by OMRON.

OMRON MAKES NO WARRANTY OR REPRESENTATION, EXPRESS OR IMPLIED, REGARDING NON-INFRINGEMENT, MERCHANTABILITY, OR FITNESS FOR PARTICULAR PURPOSE OF THE PRODUCTS. ANY BUYER OR USER ACKNOWLEDGES THAT THE BUYER OR USER ALONE HAS DETERMINED THAT THE PRODUCTS WILL SUITABLY MEET THE REQUIREMENTS OF THEIR INTENDED USE. OMRON DISCLAIMS ALL OTHER WARRANTIES, EXPRESS OR IMPLIED.

LIMITATIONS OF LIABILITY

OMRON SHALL NOT BE RESPONSIBLE FOR SPECIAL, INDIRECT, OR CONSEQUENTIAL DAMAGES, LOSS OF PROFITS, OR COMMERCIAL LOSS IN ANY WAY CONNECTED WITH THE PRODUCTS, WHETHER SUCH CLAIM IS BASED ON CONTRACT, WARRANTY, NEGLIGENCE, OR STRICT LIABILITY.

In no event shall responsibility of OMRON for any act exceed the individual price of the product on which liability is asserted.

IN NO EVENT SHALL OMRON BE RESPONSIBLE FOR WARRANTY, REPAIR, OR OTHER CLAIMS REGARDING THE PRODUCTS UNLESS OMRON'S ANALYSIS CONFIRMS THAT THE PRODUCTS WERE PROPERLY HANDLED, STORED, INSTALLED, AND MAINTAINED AND NOT SUBJECT TO CONTAMINATION, ABUSE, MISUSE, OR INAPPROPRIATE MODIFICATION OR REPAIR.

Application Considerations

SUITABILITY FOR USE

OMRON shall not be responsible for conformity with any standards, codes, or regulations that apply to the combination of products in the customer's application or use of the product.

At the customer's request, OMRON will provide applicable third party certification documents identifying ratings and limitations of use that apply to the products. This information by itself is not sufficient for a complete determination of the suitability of the products in combination with the end product, machine, system, or other application or use.

The following are some examples of applications for which particular attention must be given. This is not intended to be an exhaustive list of all possible uses of the products, nor is it intended to imply that the uses listed may be suitable for the products:

- Outdoor use, uses involving potential chemical contamination or electrical interference, or conditions or uses not described in this catalog.
- Nuclear energy control systems, combustion systems, railroad systems, aviation systems, medical equipment, amusement machines, vehicles, safety equipment, and installations subject to separate industry or government regulations.
- Systems, machines, and equipment that could present a risk to life or property.

Please know and observe all prohibitions of use applicable to the products.

NEVER USE THE PRODUCTS FOR AN APPLICATION INVOLVING SERIOUS RISK TO LIFE OR PROPERTY WITHOUT ENSURING THAT THE SYSTEM AS A WHOLE HAS BEEN DESIGNED TO ADDRESS THE RISKS, AND THAT THE OMRON PRODUCT IS PROPERLY RATED AND INSTALLED FOR THE INTENDED USE WITHIN THE OVERALL EQUIPMENT OR SYSTEM.

Disclaimers

CHANGE IN SPECIFICATIONS

Product specifications and accessories may be changed at any time based on improvements and other reasons.

It is our practice to change model numbers when published ratings or features are changed, or when significant construction changes are made. However, some specifications of the product may be changed without any notice. When in doubt, special model numbers may be assigned to fix or establish key specifications for your application on your request. Please consult with your OMRON representative at any time to confirm actual specifications of purchased product.

DIMENSIONS AND WEIGHTS

Dimensions and weights are nominal and are not to be used for manufacturing purposes, even when tolerances are shown.

ERRORS AND OMISSIONS

The information in this catalog has been carefully checked and is believed to be accurate; however, no responsibility is assumed for clerical, typographical, or proofreading errors, or omissions.

PERFORMANCE DATA

Performance data given in this catalog is provided as a guide for the user in determining suitability and does not constitute a warranty. It may represent the result of OMRON's test conditions, and the users must correlate it to actual application requirements. Actual performance is subject to the OMRON Warranty and Limitations of Liability.

PROGRAMMABLE PRODUCTS

OMRON shall not be responsible for the user's programming of a programmable product, or any consequence thereof.

COPYRIGHT AND COPY PERMISSION

This catalog shall not be copied for sales or promotions without permission.

This catalog is protected by copyright and is intended solely for use in conjunction with the product. Please notify us before copying or reproducing this catalog in any manner, for any other purpose. If copying or transmitting this catalog to another, please copy or transmit it in its entirety.